



Advance Landscape Systems

Premium Plant Protection and Landscape Solutions

Advance Landscape Systems is New Zealand's preferred choice for landscaping, revegetation and environmental solutions. We are the premier suppliers to the landcare sector, providing a wide variety of innovative products that have been both designed in house and imported from reputable manufacturers around the globe.

Our Reach

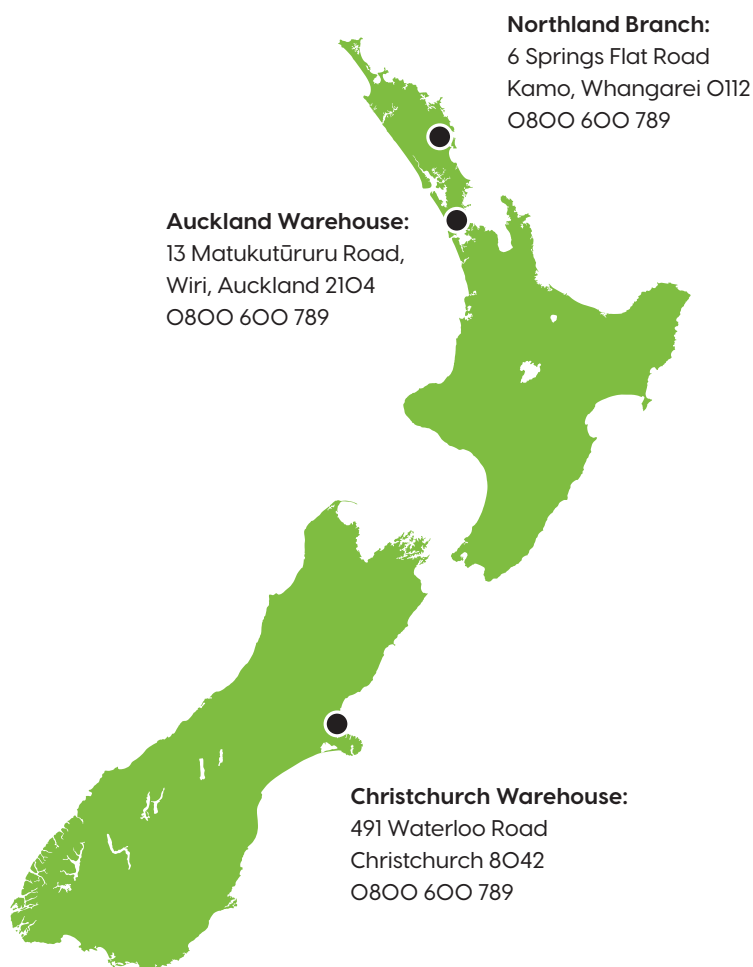

Our Consultants



Greg Suckling
021 309 263

Natural Fibre Geotextiles



Robert Bruce
021 228 3358

Plant Protection and Establishment



Matthew Strachan
021 854 665

Flex MSE Vegetated Wall Systems

Specialist Support

Each of our consultants are experienced and able to provide you with advice and technical support for specifying, project design and installation guidance. Advance Landscape Systems provide a broader range of landscape related solutions, such as custom pond liners, porous pavers, tree staking and plant protection from pests.

Contents

Stakes and Ties

- 8 Pine Stakes
- 10 Hardwood Stakes
- 12 Tree Stakes
- 13 Garden Stakes
- 14 Bamboo Stakes
- 15 Ties and Accessories

Plant Guards

- 20 Biodegradable Plant Guards
- 22 Recyclable Plant Guards
- 28 Mesh Plant Guards
- 30 Plant Guard Recycling Scheme

Weed Suppression

- 32 Natural Fibre Geotextile Range
- 34 Biodegradable Matting
- 41 Synthetic Matting
- 42 Weed Mat Fixings

Erosion Control

- 46 Erosion Blankets and Mesh
- 48 Erosion Control Logs

Plant Establishment

- 50 Browsing Repellent and Sprayers
- 51 Fertiliser
- 52 Planting and Growing
- 54 Water Saving

Ground Reinforcement

- 58 Porous Pavers
- 59 Reinforcement Mesh and Grids

Flex MSE®

- 62 Flex MSE® Vegetated Wall System

Fabrics and Accessories

- 66 Windbreak Cloth and Accessories
- 68 Shade Cloth and Privacy Mesh
- 69 Horticultural Fabrics

Water Management

- 72 Filter Fabrics
- 73 Culvert Flume
- 74 Pond Liner

Field, Track and Site

- 76 Site Marking and End Caps
- 77 Track Marking and Pest Tracking
- 78 Anti-Slip Mesh



Archipello.

Designer Elements for Modern Landscapes



CARREZ CONNECT PLANTER IN CORTEN STEEL

Archipello.

Archipello. Designer Elements for Modern Landscapes.

Introducing Archipello. – a curated collection of architecturally designed steel planters, edging and retaining wall systems, created to bring structure, form and lasting beauty to New Zealand gardens.

Exclusive to Advance Landscape Systems, Archipello. has been sourced from some of Europe's most respected manufacturers, chosen for their precision engineering, disciplined design thinking and uncompromising material standards. The result is a premium range that gives homeowners and landscapers access to truly architectural outdoor elements, products designed not just to sit in a garden, but to define it.

Architectural Steel for Living Landscapes

Archipello. embodies a simple belief: outdoor spaces deserve the same level of intention as interior spaces. Each planter, edging profile and retaining wall system is sculptural, purposeful and made to last.

Whether you are shaping a modern courtyard, defining lawn edges, building level changes, or creating a feature planting statement, Archipello. provides the structure that elevates the entire landscape.

The range includes:

- **Planters:** From organic forms like Onyx and Ellipse to bold geometric statements like Boxer and Carrez Connect.
- **Garden Edging:** Straight, Set Top and Flattened profiles for crisp borders, curved pathways and seamless transitions.
- **Retaining Walls:** Modular straight and curved systems that create strong architectural lines while managing level changes.

Premium European Corten Steel

All Archipello. Corten steel elements are manufactured using European standard S355JOWP+AR (EN10025-5), a high-strength weathering steel designed to form a stable, protective rust patina over time.

Products are delivered without rust, or partially weathered, with the natural weathering process typically developing over 4 – 5 months depending on site conditions. This evolving patina creates the warm, orange-brown finish that makes Corten steel so distinctive, while forming a protective layer that enhances durability.

The steel used in Archipello. products carries European certification EN10204-3.1 and CE / Declaration of Performance, giving you confidence that what you are installing meets rigorous international standards.

Built to Last

Archipello. is positioned at the premium end of the New Zealand market, offering a refined alternative to low-cost or short-lived options. These are not disposable garden accessories – they are long-term structural elements designed to retain their integrity and aesthetic precision for years to come.

Archipello. elements are backed by a 10-year warranty, provided the Care Guide has been followed.

For Design-Conscious Gardens

Archipello. is for homeowners who see their garden as an extension of their architecture. It is equally suited to small landscaping businesses seeking premium products that set their work apart.

From contemporary residential gardens to refined urban spaces, Archipello. delivers cohesive, high-performance elements that transform outdoor areas into structured, enduring environments.

Discover the range in-store or online – and start shaping a landscape defined by intention, strength and European design excellence.

Get inspired at archipello.co.nz

advancelandscape.co.nz/master-series/archipello/





Stakes and Ties

- 8 Pine Stakes
- 10 Hardwood Stakes
- 12 Tree Stakes
- 13 Garden Stakes
- 14 Bamboo Stakes
- 15 Ties and Accessories

Pine Stakes

Untreated Pine Stakes 50mm

- Treatment free NZ pine
- Four-sided point end for easy insertion
- Popular with local bodies for landscape trees
- Ideal for chemical-free environments



| Code | Size | Pack Qty |
|-------|---------------------------------|-----------|
| 14100 | 0.9m L x 50mm ² Pine | 10 Stakes |
| 14101 | 1.2m L x 50mm ² Pine | 10 Stakes |
| 14102 | 1.5m L x 50mm ² Pine | 10 Stakes |
| 14103 | 1.8m L x 50mm ² Pine | 10 Stakes |
| 14104 | 2.1m L x 50mm ² Pine | 10 Stakes |
| 14105 | 2.4m L x 50mm ² Pine | 10 Stakes |

Treated Pine Stakes 50mm

- H4 treated for long-lasting durability
- Four-sided point end for easy insertion
- Popular with local bodies for landscape

Save effort with our
Stake Rammer.
See page 12



| Code | Size | Pack Qty |
|-------|--------------------------------------|-----------|
| 17955 | 1.2m L x 50mm ² Pine (H4) | 10 Stakes |
| 17959 | 1.5m L x 50mm ² Pine (H4) | 10 Stakes |
| 17957 | 1.8m L x 50mm ² Pine (H4) | 10 Stakes |
| 17961 | 2.1m L x 50mm ² Pine (H4) | 10 Stakes |
| 17958 | 2.4m L x 50mm ² Pine (H4) | 10 Stakes |

Round Treated Pine Stakes 75mm

- Provides excellent staking support for 16OL + size trees
- Smooth planed machined quality
- Available in 1.8m and 2.4m. Other sizes on request

| Code | Size | Pack Qty |
|-------|-----------------|----------|
| 17991 | 1.8m L x 75mm Ø | 1 Stake |
| 17992 | 2.4m L x 75mm Ø | 1 Stake |



Untreated Pine Stakes Painted Black 50mm

- Treatment free NZ pine
- Four-sided point end for easy insertion
- Pre-painted 'Ebony' black as per Council specification
- Ideal for tree-planting in roadside and urban applications

| Code | Size | Pack Qty |
|-------|--|-----------|
| 17978 | 1.5m L x 50mm ² Pine (H4) Black | 10 Stakes |
| 17979 | 1.8m L x 50mm ² Pine (H4) Black | 10 Stakes |
| 17980 | 2.1m L x 50mm ² Pine (H4) Black | 10 Stakes |
| 17981 | 2.4m L x 50mm ² Pine (H4) Black | 10 Stakes |



Treated Pine Stakes Painted Black 50mm

- H4 treated for long-lasting durability
- Four-sided point end for easy insertion
- Pre-painted 'Ebony' black as per Council specification
- Ideal for tree-planting in roadside and urban applications

| Code | Size | Pack Qty |
|-------|--|-----------|
| 17968 | 1.2m L x 50mm ² Pine (H4) Black | 10 Stakes |
| 17969 | 1.5m L x 50mm ² Pine (H4) Black | 10 Stakes |
| 17970 | 1.8m L x 50mm ² Pine (H4) Black | 10 Stakes |
| 17971 | 2.1m L x 50mm ² Pine (H4) Black | 10 Stakes |
| 17972 | 2.4m L x 50mm ² Pine (H4) Black | 10 Stakes |

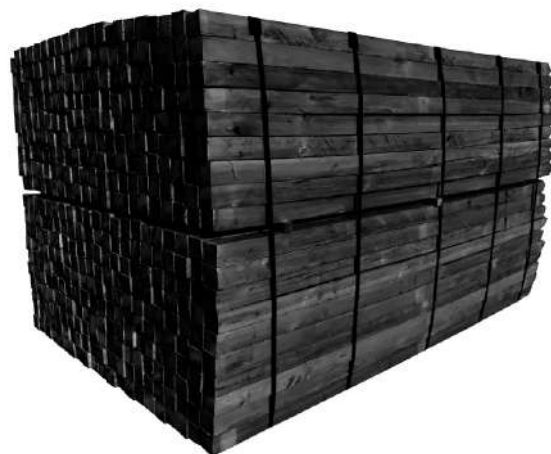

Round Treated Pine Stakes 75mm Painted Black

- Pre-painted 'Ebony' black as per Council specification
- Ideal for urban treescape aesthetics
- Also used for framing to protect trees
- Smooth planed machined quality
- Available in 1.8m and 2.4m. Other sizes on request

| Code | Size | Pack Qty |
|--------|-----------------|----------|
| 17991P | 1.8m L x 75mm Ø | 1 Stake |
| 17992P | 2.4m L x 75mm Ø | 1 Stake |



Hardwood Stakes

Hardwood Tree Stakes 75mm

- Provide strong, durable support for large trees (16OL+)
- Suitable for both commercial and residential landscapes
- Made from chemical-free, FSC-certified Mahogany hardwood
- Smooth dressed finish with a routed groove detail for a modern, high-end look
- Designed for easy installation
- Finished with a clean square tip
- Class 3 timber durability
- Expected lifespan of 5–15 years
- Ideal for a wide range of planting applications



| Code | Size | Pack Qty |
|-------|----------------------------|----------|
| 14091 | 1.8m L x 75mm ² | 1 Stake |
| 14092 | 2.1m L x 75mm ² | 1 Stake |

Hardwood Stakes 50mm

- Chemical-free Eucalypt hardwood
- Rounded pencil-point tip
- Excellent quality
- Class 3 Timber Durability - 5-15 years

| Code | Size | Pack Qty |
|-------|-------------------------------------|-----------|
| 14078 | 1.2m L x 50mm ² Hardwood | 10 Stakes |
| 14079 | 1.5m L x 50mm ² Hardwood | 10 Stakes |
| 14080 | 1.8m L x 50mm ² Hardwood | 10 Stakes |



Hardwood Stakes Painted Black 50mm

- Chemical-free Eucalypt hardwood
- Rounded pencil-point tip
- Excellent quality
- Class 3 Timber Durability - 5-15 years
- Pre-painted 'Ebony' black as per Council specification

| Code | Size | Pack Qty |
|-------|---|-----------|
| 17975 | 1.5m L x 50mm ² Hardwood Black | 10 Stakes |
| 17976 | 1.8m L x 50mm ² Hardwood Black | 10 Stakes |



Hardwood Stakes 40mm

- Chemical-free Eucalypt hardwood
- Rounded pencil-point tip
- Excellent quality
- Class 3 Timber Durability - 5-15 years
- Smooth sawn finish



| Code | Size | Pack Qty |
|-------|----------------------------|-----------|
| 14096 | 1.5m L x 40mm ² | 10 Stakes |
| 14095 | 1.8m L x 40mm ² | 10 Stakes |
| 14093 | 2.1m L x 40mm ² | 10 Stakes |

Macrocarpa Tree Stakes

- Super-strong stakes designed for long-lasting performance
- Manufactured from plantation-grown, New Zealand chemical-free Macrocarpa
- Built to withstand tough environmental conditions
- Made from quality, locally milled timber
- Durable and reliable even in demanding applications
- Treated stakes or alternative timber options available on request



| Code | Size | Pack Qty |
|-------|----------------------------|-----------|
| 14099 | 1.5m L x 38mm ² | 10 Stakes |
| 14098 | 1.8m L x 38mm ² | 10 Stakes |
| 14097 | 2.1m L x 38mm ² | 10 Stakes |

Hardwood Stakes 22mm

- Chemical-free hardwood
- Eco-sourced from selected woods which are more resistant to warp and decay than untreated pine
- Good lifespan
- Smooth sawn finish and pointed tips makes them easy to install



*22mm² is designed for SquareGuard.
See page 23*

| Code | Size | Pack Qty |
|-------|----------------------------|-----------|
| 17852 | 0.9m L x 22mm ² | 25 Stakes |
| 17869 | 1.2m L x 22mm ² | 25 Stakes |
| 17876 | 1.5m L x 22mm ² | 25 Stakes |
| 17883 | 1.8m L x 22mm ² | 25 Stakes |
| 17890 | 2.1m L x 22mm ² | 25 Stakes |

Plant Guard Hardwood Stakes

- Suitable for our TriGuard shelters
- Chemical-free hardwood
- Eco-sourced from selected woods which are more resistant to warp and decay than untreated pine
- Good lifespan



*Designed for TriGuard.
See page 22*

| Code | Size | Pack Qty |
|-------|-----------------------|-----------|
| 17905 | 0.5m L x 25mm x 10mm | 25 Stakes |
| 17900 | 0.75m L x 25mm x 14mm | 25 Stakes |
| 17901 | 0.9m L x 25mm x 14mm | 25 Stakes |
| 17906 | 1.2m L x 25mm x 14mm | 25 Stakes |

Tree Stakes

Manuka Tree Stakes

- Strong, rustic-looking support solution for securing trees during establishment
- Made from naturally durable Manuka
- Naturally resistant to rot
- Reliable alternative to treated timber
- Blends well into landscaped and rural environments
- Natural finish provides a distinctly rustic appearance
- Popular for light fencing and boundary marking



| Code | Size | Pack Qty |
|-------|---------------------------------|-----------|
| 14114 | Manuka tree stakes 1.8m 15-30mm | 10 Stakes |
| 14115 | Manuka tree stakes 2.4m 20-40mm | 10 Stakes |

Recycled Plant & Tree Stakes

- Made from recycled kerbside plastic
- Solid robust profile
- Lightweight and splinter-free
- Ideal for gardens, landscaping, and orchards
- Reusable design
- Can be nailed or screwed



| Code | Size | Pack Qty |
|-------|--------------------------|----------|
| 16100 | 0.9m x 23mm ² | 6 Stakes |
| 16101 | 1.2m x 23mm ² | 6 Stakes |
| 16110 | 1.5m x 38mm ² | 6 Stakes |
| 16111 | 1.8m x 38mm ² | 6 Stakes |

Steel Reinforcing Rods

- Provides strong and stable anchoring for tree guards
- Suitable for use with heavy-duty guards like TreeTube Maxi
- Resists bending and displacement in exposed conditions
- Secures trees against cattle, sheep, goats, and other large animals
- Long-lasting and corrosion-resistant for extended field use



Use with TreeTube Maxi.
See page 29

| Code | Size | Pack Qty |
|-------|---------------|----------|
| 17100 | 1.2m L x 12mm | 10 Rods |
| 17101 | 1.7m L x 12mm | 10 Rods |
| 17102 | 2.1m L x 12mm | 10 Rods |

TerraGear™ Tree Stake Rammer

- Custom designed to fit all tree stakes 50x50mm and less
- 90mm internal diameter
- Fast and easy driving of either Y-Posts (plastic or metal) or wooden stakes (up to 50x50mm) into the ground

| Code | Description | Pack Qty |
|-------|-------------------|----------------|
| 26028 | Tree Stake Rammer | 1 Stake Rammer |



Garden Stakes

Eslon Stakes

Plastic Coated Steel

- NZ's most popular domestic garden stake
- Far superior to imitation brands
- Watertight, weatherproof sealed caps at either end ensure long life
- Tough hollow steel core that will not crack, rot or easily buckle
- Unique, moulded UV resistant plastic coating allows attachment of plant ties at any point
- Sealed end spike allows easy insertion
- Nine popular sizes - 0.9m to 2.4m buckle

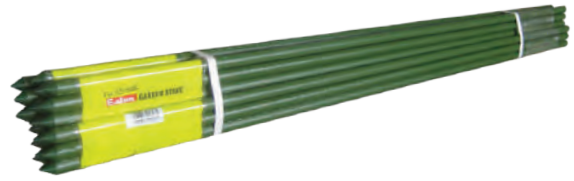
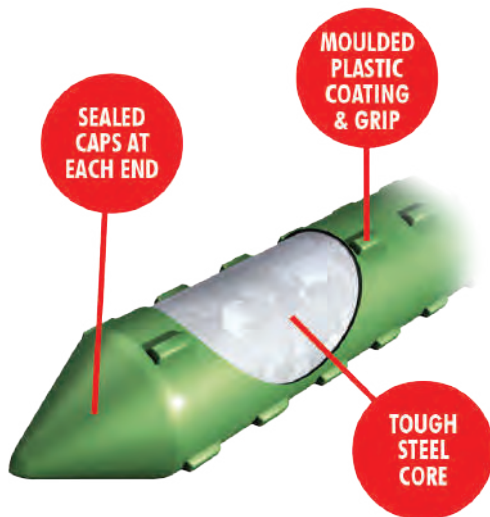

| Code | Size | Pack Size |
|-------|----------------------------|-----------|
| 11214 | 0.9m L x 8mm Ø | 12 Stakes |
| 11510 | 0.9m L x 11mm Ø Heavy Duty | 12 Stakes |
| 11283 | 1.2m L x 11mm Ø | 12 Stakes |
| 11520 | 1.2m L x 16mm Ø Heavy Duty | 12 Stakes |
| 11290 | 1.5m L x 11mm Ø | 12 Stakes |
| 11530 | 1.5m L x 16mm Ø Heavy Duty | 12 Stakes |
| 11412 | 1.8m L x 16mm Ø | 12 Stakes |
| 11429 | 2.1m L x 16mm Ø | 6 Stakes |
| 11504 | 2.4m L x 20mm Ø | 6 Stakes |

Fiberglass Rods

- Non-conductive and non-corrosive white fiberglass rods
- Flexible and lightweight
- 2m x 10mm rods
- Ideal for a number of applications in the farming and planting industry

| Code | Size | Pack Qty |
|-------|-------------|----------|
| 26168 | 2m x 10mm Ø | 10 Rods |



Bamboo Stakes

Bamboo Stakes

- Emperor™ Bamboo – the only choice for natural bamboo stakes in NZ
- Sourced exclusively from sustainable bamboo plantations
- 100% natural product
- Fully graded for consistency
- A sustainable choice with Bamboo being one of the fastest-growing renewable resources on the planet
- Other sizes available on indent order



EMPEROR™
BAMBOO

| Code | Size | Pack Size | Bale Size |
|--------|---------------------|-----------|-----------|
| 15100A | 0.5m L x 10-12mm Ø | 100 | 400 |
| 15060 | 0.6m L x 8-10mm Ø | 100 | 500 |
| 15101A | 0.6m L x 10-12mm Ø | 100 | 400 |
| 15081 | 0.75m L x 10-12mm Ø | 100 | 400 |
| 15080 | 0.75m L x 12-14mm Ø | 100 | 200 |
| 15062 | 0.9m L x 8-10mm Ø | 100 | 500 |
| 15063 | 0.9m L x 10-12mm Ø | 100 | 400 |
| 15065 | 1.2m L x 8-10mm Ø | 100 | 400 |
| 15064 | 1.2m L x 10-12mm Ø | 100 | 400 |
| 15079 | 1.2m L x 12-14mm Ø | 100 | 300 |
| 15073 | 1.5m L x 10-12mm Ø | 100 | 300 |
| 15066 | 1.5m L x 12-14mm Ø | 100 | 200 |
| 15088 | 1.8m L x 10-12mm Ø | 100 | 200 |
| 15068 | 1.8m L x 14-16mm Ø | 100 | 100 |
| 15070 | 2.4m L x 16-18mm Ø | 100 | 100 |
| 15072 | 2.4m L x 18-20mm Ø | 100 | 100 |
| 15074 | 2.4m L x 20-22mm Ø | 50 | 50 |



Flower Sticks

- Bamboo Flower Sticks come pointed and dyed green
- Great for staking taller plants or flowers which can be susceptible to wind damage



| Code | Size | Pack Qty |
|-------|------------|----------|
| 15093 | 60cm x 5mm | 100 |
| 15094 | 90cm x 7mm | 100 |

Jute Tree Tie Webbing

- Jute tree-tie is the eco-friendly alternative to Poly Tree Tie
- Biodegrades after approximately 2-3 years
- Ideal for today's ecologically sensitive landscaper



| Code | Size | Pack Qty |
|-------|-----------------|----------|
| 21483 | 50mm x 33m Roll | 1 Roll |



Poly Tree Tie Webbing

- The traditional landscape tree-tie system
- Poly tree tie webbing is used extensively NZ wide in both streetscape and general landscaping situations
- Immensely durable and gentle on the tree
- Lasts four to six years before breaking down
- UV stabilised



| Code | Size | Pack Qty |
|-------|------------------|----------|
| 21491 | 50mm x 100m Roll | 1 Roll |

Elastic Tree Tie Webbing

- 50mm width for greater support
- Designed for larger trees
- Elasticity reduces whiplash in high wind areas



| Code | Size | Pack Qty |
|-------|-----------------|----------|
| 21485 | 50mm x 50m Roll | 1 Roll |

Tree-Tie Stapler Heavy Duty

- Used to attach Tree Tie Webbing to stakes
- 12mm Galvanised or Stainless Steel staples



| Code | Size | Pack Size |
|-------|---------------------------|--------------|
| 25903 | VX 500 Heavy Duty Stapler | 1 Unit |
| 25906 | Galvanised Staples (12mm) | 5000 Staples |
| 25907 | Stainless Staples (12mm) | 5000 Staples |

Tree-Tie Stapler Light Duty

- Used to attach Tree Tie Webbing to stakes
- 10mm Galvanised staples



| Code | Size | Pack Qty |
|-------|---------------------------|--------------|
| 25900 | J23/10 Stapler Light Duty | 1 Stapler |
| 25902 | Galv Staples (10mm) | 1000 Staples |

Super Soft Tree Ties

- Soft synthetic rubber tie for larger plants and landscape trees
- Figure eight design cushions bark against stake
- Fully adjustable as tree grows
- Long lasting and UV stable



| Code | Size | Pack Size |
|-------|------|-----------|
| 21460 | 50cm | 1 Tie |

Speedi Ties

- Synthetic rubber adjustable ties
- Quick and easy to use
- Two sizes - good for a large range of applications



| Code | Size | Pack Size |
|-------|-------|-----------|
| 21175 | 175mm | 100 Ties |
| 21176 | 310mm | 100 Ties |

Secura Tree Tie

- Adjustable, reusable tree tie
- Commonly used in nursery settings with guide-wire systems
- Easily attaches to guide wires
- Wraps around the tree stem for safe, stable support
- UV-stable and super tough
- Practical and long-lasting
- Suitable for stems 20–80 mm in diameter



| Code | Size | Pack Size |
|-------|----------------|-----------|
| 21510 | 20–80 mm stems | 1 Tie |

TerraTie Cable Ties

- Ideal for securing plants and vines quickly
- Use to secure netting plant protectors to stakes
- Strong UV stable nylon ratchet type tie
- Low cost solution to a range of garden applications



| Code | Size | Pack Size |
|-------|-------|-----------|
| 21207 | 100mm | 100 Ties |
| 21208 | 200mm | 100 Ties |
| 21209 | 250mm | 100 Ties |
| 21210 | 300mm | 100 Ties |

Max-Tapener Tool

- Excellent for rapid tying of stakes to young seedlings
- Saves time by single action tying
- Use on grapes, roses, tomato plants etc.
- Tapes available in green or black



| Code | Size | Pack Size |
|-------|--------------------|----------------|
| 25991 | Max Tapener Tool | 1 Tapener Tool |
| 25997 | TBS Tapener Tool | 1 Tapener Tool |
| 25999 | TBS Tapener Blades | 3 Blades |
| 25989 | Tapener Staples | 4800 Staples |
| 25996 | Max Tapener Blades | 2 Blades |

| Code | Size | Pack Size |
|-------|------------------------------|-----------|
| 25992 | Black Tape 20mu (11mm x 30m) | 10 Rolls |
| 25998 | Green Tape 15mu (11mm x 20m) | 10 Rolls |

Cloth Garden Ties

- Tough textile-strip tie
- Easy to use and very cost effective
- Lasts typically 1-2 years
- Comes in a 25m roll
- One of our biggest sellers



| Code | Size | Pack Qty |
|-------|----------|----------|
| 21470 | 25m Roll | 1 Roll |

Foam Wire Plant and Tree Tie

- Cushioned foam tree tie with galvanised wire core
- Gentle on plant stems
- Pliable and easy to install
- 10mm x 10m roll



| Code | Size | Pack Qty |
|-------|----------|----------|
| 21606 | 10m Roll | 1 Roll |

TerraGear™ Rubber Mallet

- 16oz size
- Minimal bounce back and vibration
- Excellent weight for quick insertion of pins/pegs and bamboo stakes

| Code | Description | Pack Qty |
|-------|---------------|----------|
| 26029 | Rubber Mallet | 1 Mallet |





Plant Guards

| | |
|----|------------------------------|
| 20 | Biodegradable Plant Guards |
| 22 | Recyclable Plant Guards |
| 28 | Mesh Plant Guards |
| 30 | Plant Guard Recycling Scheme |

Biodegradable Plant Guards

FiberGuard™ 2.0

100% biodegradable pre-assembled plant guard

FiberGuard 2.0 is the improved version of the original FiberGuard, designed for quick, reliable protection of young native plants and trees.

- Pre-assembled design reduces installation time by up to 50%
- Sloped shape allows easy placement on hillsides
- Neutral colour blends naturally into landscapes
- Fully biodegradable with no removal required
- Provides effective plant protection for up to 24 months, depending on site conditions
- Ideal for large-scale planting, volunteer groups, and community events
- Supports a low-carbon, sustainable planting approach
- Manufactured in New Zealand



Combo (Guard & Stakes)

| Code | Description | Pack Qty |
|------|---|-----------|
| 3992 | 300mm Combo (Includes Guard, 2x bamboo) | 50 Combos |
| 3993 | 450mm Combo (Includes Guard, 2x bamboo) | 50 Combos |

Kits (Guard, Stakes & Mat)

| Code | Size | Pack Qty |
|-------|---|----------|
| 3996 | 300mm Kit (Includes Guard, 2x bamboo, EcoCoir Mat) | 50 Kits |
| 3996A | 300mm Kit (Includes Guard, 2x bamboo, EcoWool Mat) | 50 Kits |
| 3998 | 300mm Kit (Includes Guard, 2x bamboo, FuturFiber Hemp Mat) | 50 Kits |
| 3997 | 450mm Kit (Includes Guard, 2x bamboo, EcoCoir Mat) | 50 Kits |
| 3997A | 450mm Kit (Includes Guard, 2x bamboo, EcoWool Mat) | 50 Kits |
| 3999 | 450mm Kit (Includes Guard, 2x bamboo, FuturFiber Hemp Mat) | 50 Kits |



FiberGuard 2.0 450

FiberGuard 2.0 300

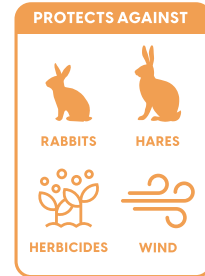

FiberGuard™ Original

100% biodegradable wrap-around plant guard

Designed with the ability to join two guards together to wrap around larger plants.

- Secure installation using an innovative tab-and-slot system
- Protects plants from browsing animals, spray drift, and harsh weather
- Creates a sheltered micro-climate that supports early growth and survival
- Constructed from tough recycled fibreboard with high wet-strength performance
- Guards can be joined together for larger plants such as roses, shrubs, and hebes
- Manufactured in New Zealand



Combo (Guard & Stakes)

| Code | Description | Pack Qty |
|------|---|-----------|
| 3973 | 300mm Combo (Includes Guard, 2x bamboo) | 50 Combos |
| 3976 | 450mm Combo (Includes Guard, 2x bamboo) | 50 Combos |

Kits (Guard, Stakes & Mat)

| Code | Size | Pack Qty |
|-------|---|----------|
| 3979 | 300mm Kit (Includes Guard, 2x bamboo, EcoCoir Mat) | 50 Kits |
| 3979A | 300mm Kit (Includes Guard, 2x bamboo, EcoWool Mat) | 50 Kits |
| 3983 | 300mm Kit (Includes Guard, 2x bamboo, FuturFiber Hemp Mat) | 50 Kits |
| 3982 | 450mm Kit (Includes Guard, 2x bamboo, EcoCoir Mat) | 50 Kits |
| 3982A | 450mm Kit (Includes Guard, 2x bamboo, EcoWool Mat) | 50 Kits |
| 3984 | 450mm Kit (Includes Guard, 2x bamboo, FuturFiber Hemp Mat) | 50 Kits |

FiberGuard™

FiberGuard 300

PROTECTS AGAINST

RABBITS HERBICIDES

FiberGuard 450

PROTECTS AGAINST

RABBITS HARES

HERBICIDES WIND



Recyclable Plant Guards

KBC™ TriGuard

Double Wall Design

- Made from UV-stable polypropylene
- Reusable if removed before the plant becomes too large
- Snap-open design saves installation time and labour costs
- Lifespan of 2–4 years, depending on environmental conditions
- Protects plants from browsing animals, sprays, and wind
- Twin-wall design creates a beneficial micro-climate
- Performs well in high-wind conditions
- Easy to transport
- Requires only one hardwood stake (included)
- Recyclable through the Plant Guard to Post Recycling Scheme

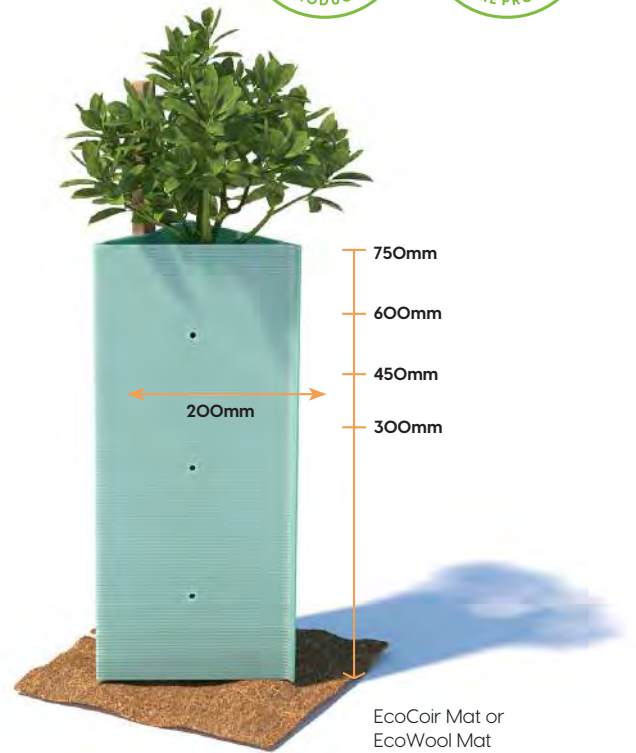

Guard Only

| Code | Size | Pack Qty |
|------|-------------------------|-----------|
| 3950 | 300 H x 200 W x 200mm D | 50 Guards |
| 3952 | 450 H x 200 W x 200mm D | 50 Guards |
| 3954 | 600 H x 200 W x 200mm D | 50 Guards |
| 3956 | 750 H x 200 W x 200mm D | 50 Guards |

Kit (Guard, Stakes & 'EcoCoir' Mat)

| Code | Size | Pack Qty |
|------|-------------------------|----------|
| 2105 | 300 H x 200 W x 200mm D | 50 Kits |
| 2106 | 450 H x 200 W x 200mm D | 50 Kits |
| 2107 | 600 H x 200 W x 200mm D | 50 Kits |
| 2108 | 750 H x 200 W x 200mm D | 50 Kits |

Combo (Guard & Hardwood Stake Only)

| Code | Size | Pack Qty |
|-------|-------------------------|-----------|
| 3950R | 300 H x 200 W x 200mm D | 50 Combos |
| 3952R | 450 H x 200 W x 200mm D | 50 Combos |
| 3954R | 600 H x 200 W x 200mm D | 50 Combos |
| 3956R | 750 H x 200 W x 200mm D | 50 Combos |

Kit (Guard, Stakes & 'EcoWool' Mat)

| Code | Size | Pack Qty |
|-------|-------------------------|----------|
| 2105A | 300 H x 200 W x 200mm D | 50 Kits |
| 2106A | 450 H x 200 W x 200mm D | 50 Kits |
| 2107A | 600 H x 200 W x 200mm D | 50 Kits |
| 2108A | 750 H x 200 W x 200mm D | 50 Kits |



KBC™ SquareGuard

Provides protection from larger browsing animals with a 1.2m option

- Requires only one wooden stake
- Made from UV-stable polypropylene
- Lifespan of 2–4 years, depending on environmental conditions
- Protects against browsing animals, sprays, and wind
- Provides protection from larger browsing animals, available in 600, 750 and 1200mm heights
- Wrap-around design allows guard to be removed and reused
- Twin-wall design creates a protective microclimate
- Performs well in high-wind conditions
- Easy to transport
- Recyclable through the Plant Guard to Post Recycling Scheme

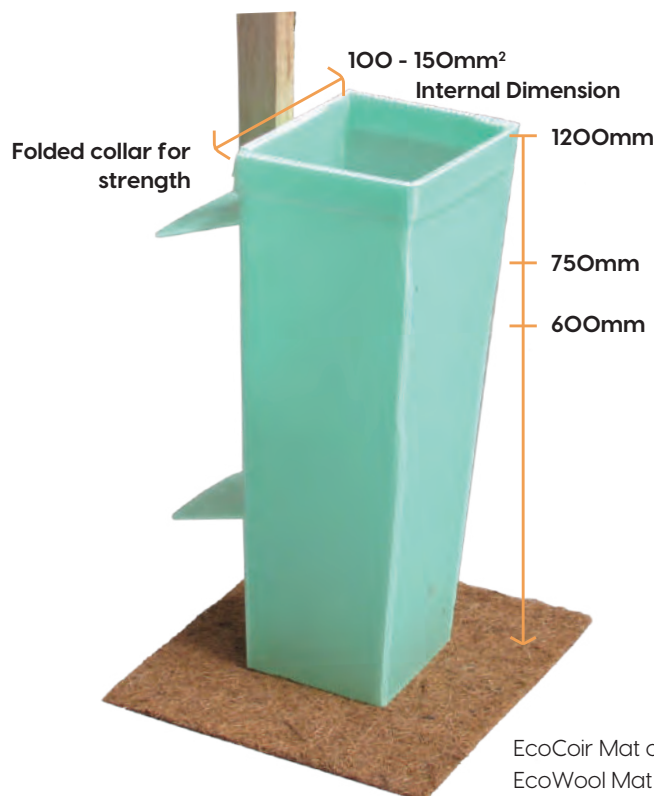

| Code | Size | Pack Qty |
|-------|---|-----------|
| 2100 | 600/100mm Kit - Includes Guard, 1x stake, EcoCoir Mulch mat | 50 Kits |
| 2100A | 600/100mm Kit - Includes Guard, 1x stake, EcoWool Mulch mat | 50 Kits |
| 1011 | 600/100mm - Guard Only | 50 Guards |
| 2101 | 600/150mm Kit - Includes Guard, 1x stake, EcoCoir Mulch mat | 50 Kits |
| 2101A | 600/150mm Kit - Includes Guard, 1x stake, EcoWool Mulch mat | 50 Kits |
| 1012 | 600/150mm - Guard Only | 50 Guards |
| 2103 | 750mm Kit - Includes Guard, 1x stake, EcoCoir Mulch mat | 50 Kits |
| 2103A | 750mm Kit - Includes Guard, 1x stake, EcoWool Mulch mat | 50 Kits |
| 1014 | 750mm - Guard Only | 50 Guards |
| 2109 | 1200mm Kit - Includes Guard, 1x stake, EcoCoir Mulch mat | 25 Kits |
| 2109A | 1200mm Kit - Includes Guard, 1x stake, EcoWool Mulch mat | 25 Kits |
| 1015 | 1200mm - Guard Only | 25 Guards |

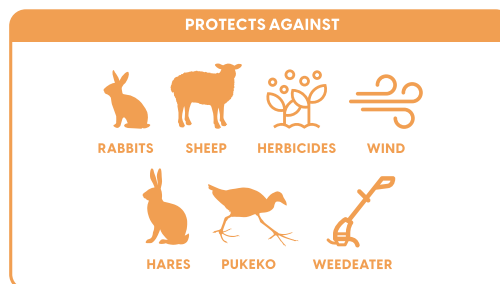

KBC™ CombiShield

Double Wall Design

- CombiShield Plant Guard 300 mm system designed for low-cost, large-scale native revegetation and restoration projects
- Tough, twin-wall, translucent UV-stable 300 mm sleeve with inner measurements of 130 mm square
- Available as a complete kit combining the guard with two bamboo stakes and a natural mulch mat for weed suppression
- Enables the use of smaller, lower-cost plants, reducing overall establishment costs
- Extremely fast to install and easy to maintain
- Protects seedlings from wind, foraging pests, herbicide spray, frost, and moisture loss
- Suppresses competing weeds and helps retain soil moisture
- Promotes higher plant survival rates and faster, healthier root and stem growth
- Reduces ongoing maintenance requirements across planting programs
- Recyclable through the Plant Guard to Post Recycling Scheme



| Code | Size | Pack Qty |
|-------|---|------------|
| 1010 | CombiShield - Guard Only | 100 Guards |
| 3703R | CombiShield Combo - Includes 1 Guard, 2 x Bamboo | 100 Combos |
| 3703 | CombiShield Kit - includes 1 Guard, 2 x Bamboo, 1 x EcoCoir 200mm Mat | 100 Kits |
| 3702 | CombiShield Kit - includes 1 Guard, 2 x Bamboo, 1 x EcoWool 200mm Mat | 100 Kits |

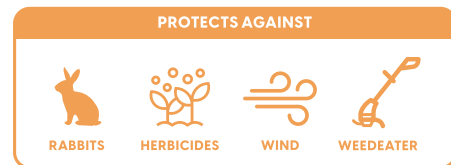

KBC™ CombiGuard

Low Cost Solution

- CombiGuard plant protection system suitable for both large and small-scale revegetation projects
- Protects plants from wind, browsing animals, and herbicide spray
- 300mm guard provides protection against rabbits; taller 400–500mm options recommended for protection against hares and possums
- Low establishment cost, enabling the use of smaller, lower-cost seedlings
- Increases plant survival rates by reducing damage from animals, desiccating winds, and frosty ground
- Promotes faster, healthier growth through strong root and stem development
- Suppresses competing weeds, reducing site maintenance and ongoing labour costs
- Unobtrusive tan-tinted design blends naturally into the landscape while remaining easy to locate for maintenance
- Proven, easy-maintenance design widely used across planting projects

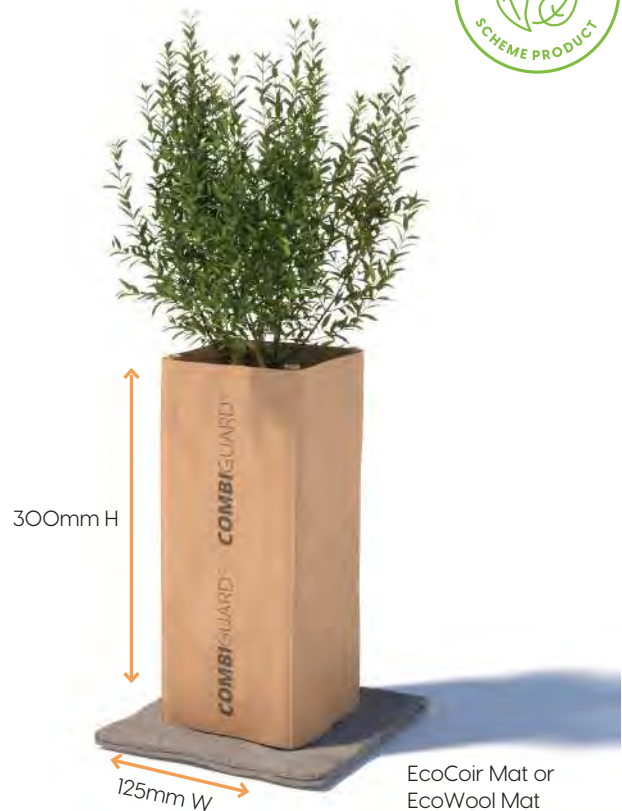

PROTECTS AGAINST

RABBITS

HERBICIDES

WIND

CombiGuard 300mm (Tan or Green)

| Code | Size | Pack Qty |
|--------------|--|------------|
| 3600 | 300mm Tan Sleeve Only | 100 Guards |
| 3600G | 300mm Green Sleeve Only | 100 Guards |
| 3700 | 300mm Kit - includes Tan Sleeve, 4 x Bamboo, EcoWool Mat | 100 Kits |
| 3700G | 300mm Kit - includes Green Sleeve, 4 x Bamboo, EcoWool Mat | 100 Kits |
| 3701 | 300mm Kit - includes Tan Sleeve, 4 x Bamboo, EcoCoir Mat | 100 Kits |
| 3701G | 300mm Kit - includes Green Sleeve, 4 x Bamboo, EcoCoir Mat | 100 Kits |

CombiGuard 400mm - 500mm (Tan)

| Code | Size | Pack Qty |
|-------------|--|------------|
| 3602 | 400mm Tan Sleeve Only | 100 Guards |
| 3720 | 400mm Kit - includes Tan Sleeve, 4 x Bamboo, EcoWool Mat | 100 Kits |
| 3721 | 400mm Kit - includes Tan Sleeve, 4 x Bamboo, EcoCoir Mat | 100 Kits |
| 3603 | 500mm Tan Sleeve Only | 100 Guards |
| 3705 | 500mm Kit - includes Tan Sleeve, 4 x Bamboo, EcoWool Mat | 100 Kits |
| 3706 | 500mm Kit - includes Tan Sleeve, 4 x Bamboo, EcoCoir Mat | 100 Kits |



KBC™ Willow & Poplar Sleeve Tree Shelter Tubes

- Twin-walled, rigid tree shelter sleeves for premium protection for up to 7 years
- Available in 3 sizes: 1.2m (sheep protection), 1.7m (cattle protection), and 2.0m (deer protection)
- Made from UV-stabilised recycled plastic
- Flared rims reduce stem abrasion
- Perforated 'easy-tear' laser lines allow the sleeve to split as the tree grows
- Green colour supports photomorphogenesis by balancing light wavelengths
- Rigid tube design allows easy installation over poles or trees
- Proven to increase tree survival rates
- Helps reduce moisture loss during dry conditions
- Deflects erosion debris during flood events
- Supplied nested in packs of 3 sleeves, with outer bundles of 27
- Nested sleeve diameters: 120mm, 110mm, and 102mm
- Recyclable through the 'Plant Guard to Post Recycling Scheme'



| Code | Size | Pack Qty | Bundle Qty |
|------|---------------------------------|-----------|------------|
| 3045 | KBC Willow & Poplar Sleeve 1.2m | 3 Sleeves | 27 Sleeves |
| 3046 | KBC Willow & Poplar Sleeve 1.7m | 3 Sleeves | 27 Sleeves |
| 3047 | KBC Willow & Poplar Sleeve 2m | 3 Sleeves | 27 Sleeves |

KBC™ VineGuard

- Made from twin-wall UV stable polypropylene
- Provides sufficient light for small vines while giving ideal microclimate growing conditions
- Encourages strong leader
- Protects against browsing animals
- Protects from herbicide spray
- Top tab clips onto trellis wire
- Base can be opened for vine maintenance
- Recyclable through the 'Plant Guard to Post Recycling Scheme'



| Code | Description | Pack Qty |
|------|-----------------|-----------|
| 3953 | 900mm VineGuard | 50 Guards |

KBC™ SpraySleeve

- 500mm high x 100mm open diameter
- HDPE sleeve designed for economical protection against chemical sprays and rabbit damage
- Available either slit or unslit
- Recyclable through the 'Plant Guard to Post Recycling Scheme'

| Code | Description | Pack Qty |
|------|--------------------|-------------|
| 3032 | SpraySleeve Unslit | 100 Sleeves |
| 3033 | SpraySleeve Slit | 100 Sleeves |



Secure sleeve with bamboo stakes.
See page 14



KBC™ Wide TreeSleeve Roll

- 160mm open diameter x 200 metre roll
- Protects against sprays and browsing animals
- A continuous roll that can be cut to any length required
- Designed especially as an economy option for cost savings
- Can be secured with hardwood or bamboo stakes
- Recyclable through the 'Plant Guard to Post Recycling Scheme'

| Code | Description | Pack Qty |
|------|-------------------|----------|
| 3035 | 160mm x 200m roll | 1 Roll |



G22 Fencing Ring Pliers & D-rings

- Fencing ring pliers and galvanised D-rings designed for closing wire mesh plant protectors
- Ideal for securely fastening hexagonal wire netting providing a strong and reliable connection

| Code | Description | Pack Qty |
|-------|---------------------|------------|
| 25908 | G22 Hog Ring Pliers | 1 Unit |
| 25909 | Galv D-Rings 14Ga. | 1000 Rings |



Mesh Plant Guards

KBC™ Handy Mesh

Protect against browsing animals

- Easily cut roll of very strong UV stable self-supporting plastic mesh
- Protects against rabbits, hares, possums and sheep
- Simply cut to preferred diameter and form a protective fence around young seedlings
- Staking recommended for further stability (see our stake range)
- Secure to stake with cable ties (see page 19)
- Manufactured from UV stabilised HDPE

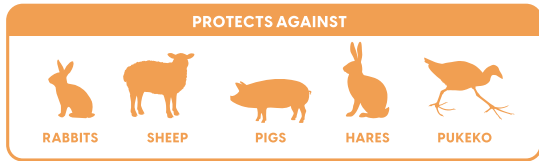

| Code | Size | Pack Qty |
|------|-------------------------|----------|
| 3022 | 0.9m W x 30m Roll Black | 1 Roll |
| 3023 | 0.9m W x 30m Roll Green | 1 Roll |



Hexagonal Wire Netting

Use for protectors, fencing, aviaries etc.

- An alternative to plastic mesh
- Netting will prevent damage from browsing rabbits, hares, and possums
- Galvanized 38mm Hexagonal Wire Netting
- Other sizes available on request.



Secure your netting with hog rings.
See page 29.

| Code | Size | Pack Qty |
|------|--------------|----------|
| 3026 | 450mm x 50m | 1 Roll |
| 3027 | 600mm x 50m | 1 Roll |
| 3028 | 900mm x 50m | 1 Roll |
| 3029 | 1200mm x 50m | 1 Roll |

KBC™ NetSleeve Roll

Lightweight mesh for small seedlings

- Protects against browsing rabbits, possums and birds
- The lowest cost seedling protector available
- Continuous netting sleeve made from UV stable plastic
- Simply cut to length and slide over young seedlings
- Very quick to install - great for larger revegetation projects etc where cost is a major consideration
- This is the same product as Netlon



| Code | Description | Pack Qty |
|------|-------------------|----------|
| 3019 | 200mm dia. x 250m | 1 Roll |

KBC™ TreeTube

Rolls or cut lengths

- Heavy-duty, self-supporting plastic mesh tubes for plant and tree protection
- Simply cut roll to length as required or purchase as cut lengths
- Suitable for protecting new plantings from browsing animals
- Protection ranges from small animals (rabbits, hares, pukeko) up to cattle (TreeTube Maxi)
- Manufactured from UV-stabilised HDPE for long-term outdoor durability
- Flexible structure absorbs animal pressure without damage
- Excellent wind and UV resistance
- Supplied as rolls or pre-cut lengths
- TreeTube Maxi version supplied as 1.7 m pre-cut tubes
- Support options include fiberglass rods, bamboo, or timber stakes
- Stakes or rods can be inserted through mesh openings or fixed using ties



KBC™ TreeTube (Rolls & 500mm Cut-Lengths)

| Code | Size | Pack Qty |
|------|----------------------|----------------|
| 3024 | 250mm dia. x 30m | 1 Roll |
| 3021 | 250mm dia. x 500mm H | 25 Cut Lengths |

KBC™ TreeTube Maxi (Pre-cut 1.7m Lengths)

| Code | Size | Pack Qty |
|------|---|---------------|
| 3042 | 1.7m x 45cm flat | 5 Cut Lengths |
| 3043 | 1.7m x 45cm combo (includes 2 x 2m fiberglass rods) | 5 Kits |

Mesh Trunk Guard

Tree Protection Tube

- Protects lignified stems from abrasion and ringbarking by animals
- Self-wrapping, expanding design grows with the tree
- Coils naturally and fits snugly around the trunk
- Maintains spiral shape while gently opening without damaging the tree
- UV-stabilised and weather resistant for New Zealand conditions
- Long-lasting performance of up to 6 years
- Flexible mesh allows quick installation with no stakes required
- Maximum trunk diameter 11 cm

| Code | Size | Pack Qty |
|------|------------------------|----------|
| 3056 | Mesh Trunk Guard 325mm | 1 Guard |
| 3053 | Mesh Trunk Guard 550mm | 1 Guard |



What's next for your retired plastic plant guards?

We have a solution!

The Challenge

Many of our customers love our KBC plastic guards for their durability and cost-effectiveness. We always encourage re-use, but eventually these plant guards reach the end of their life.

The Solution

Future Post, an innovative New Zealand company, recycles plastic waste into BioGro™ certified fence posts. This reduces landfill and provides an eco-friendly alternative to treated timber fencing.



future POST



Why We Partnered with Future Post

- Shared sustainability values
- BioGro™ certified products
- Guards can be returned straight from the field with no cleaning required
- Innovative solutions for plastic waste

How You Can Recycle Your Guards

1. Visit www.advancelandscape.co.nz/sustainability/#recycling and complete the Return Form
2. Include proof of purchase
3. Package your guards with no cleaning required
4. We verify your form and send a Return Authorisation number to include with your returned guards

Questions?

Call our friendly team on **0800 600 789**

Recycle your guards and help create a positive environmental impact!



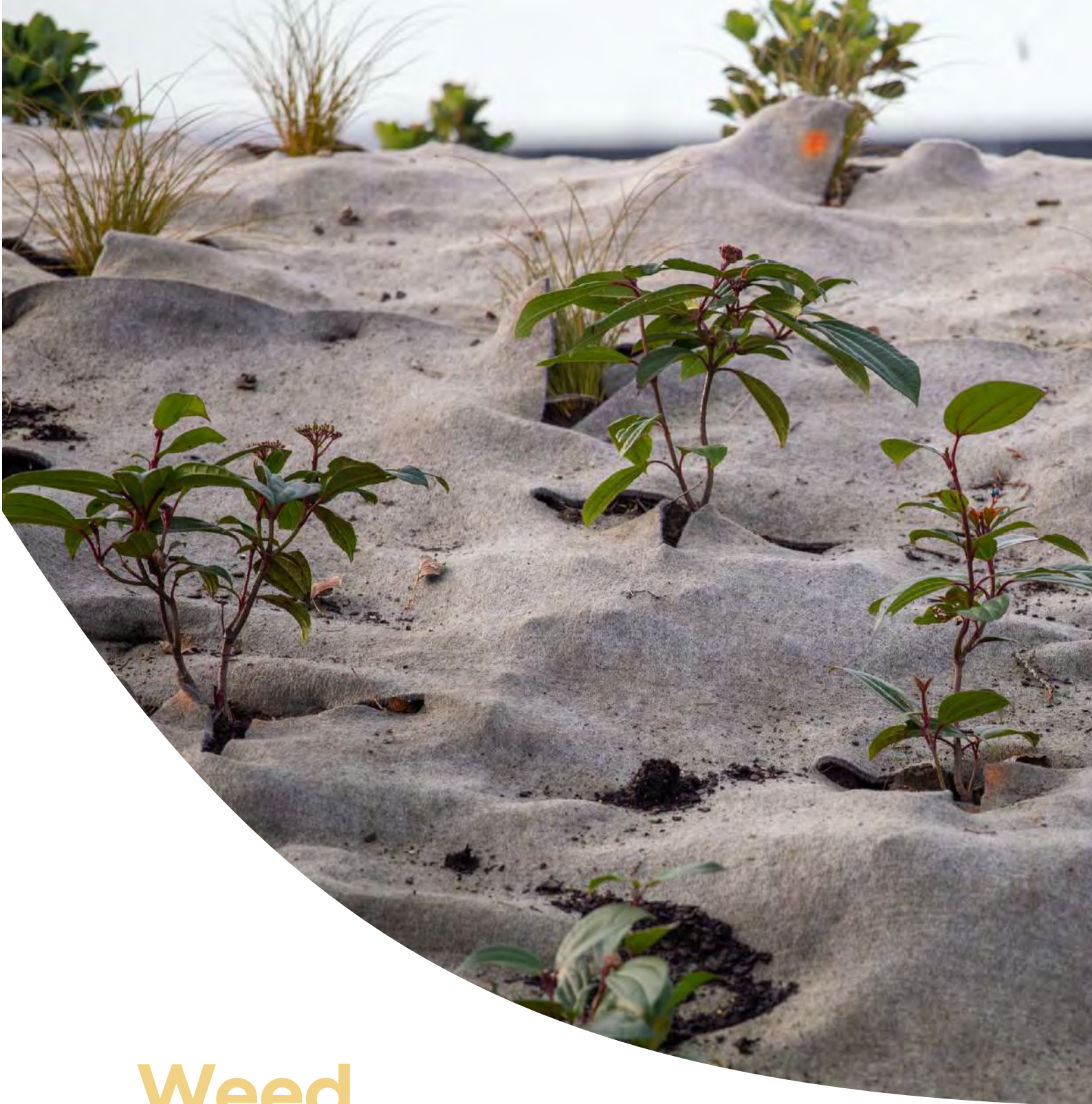

Weed Suppression

- 32 Natural Fibre Geotextile Range
- 34 Biodegradable Matting
- 41 Synthetic Matting
- 42 Weed Mat Fixings

Natural Fibre Geotextiles

FuturFiber® and EcoWool™

MADE BY rubisco®

Hemp, Dag Wool and Waste Wool Matting
For effective erosion control and weed suppression.

Natural Fibre Geotextiles and FuturFiber®

Advance natural geotextile solutions are designed to directly support the core values and goals of specifiers, landscape architects, councils, and clients alike.

We prioritise biodegradability and sustainable sourcing, ensuring our products are environmentally responsible from origin to end of life. By reducing carbon emissions across operations, manufacturing, and supply, and supporting Net Zero objectives, we help projects meet today's climate and sustainability standards.

Our FuturFiber® Hemp & Wool range carries EPD certification – the first in this industry – and is also BioGro Certified, developed to meet organic standards.

We manufacture our geotextiles on state-of-the-art needle looms, and can output rolls up to 6m wide and 50m long, in weights from 300gsm up to 1200gsm. This versatility allows clients to reduce joins and ensure successful weed control and plant establishment. Densely needle-punching our geotextiles ensures durability and longevity in the field.

Alongside their environmental credentials, our products deliver proven performance in weed and erosion control, with premium quality, bulk supply options, and efficient logistics that ensure economical and successful project delivery.

The outcomes are tangible:

- Reduced pests and weed spread
- Erosion stabilised soil and slopes
- Increased food production
- Improved water quality



FuturFiber®
MADE BY rubisco®

FuturFiber® Hemp

Hemp is one of the strongest natural fibres on earth, providing the durability of a synthetic fibre while still being fully biodegradable. FuturFiber® Hemp matting harnesses the strength and absorbency of hemp fibre creating a moist environment for plant growth, while providing unmatched weed suppression qualities.

Made from South Island hemp cultivated and processed within Rubisco's vertically integrated hemp fibre platform, blended with New Zealand strong wool, the needle-punched non-woven geotextiles provide strength, permeability, and soil stability without the use of microplastics.



FuturFiber® DagWool

FuturFiber® Dag Wool natural fibre geotextile rolls are made from BioGro certified dag wool. These matting rolls provide maximum effectiveness where soil conservation and weed suppression are required. Recommended for small and large scale planting and erosion control projects.

The FuturFiber Hemp and Dag Wool range offers matting and cut-mat products for private and public green spaces, designed to manage weeds and erosion around plantings, and provide plants and trees with moisture control and nutrient release to support healthy establishment.



EcoWool™

EcoWool is a fully biodegradable non-woven wool matting used in the establishment of trees, shrubs and groundcovers in landscape plantings.

Recommended for small and large scale planting projects where soil conservation and temporary weed suppression are required.



Biodegradable Matting

FuturFiber® Hemp Matting

600 & 1000gsm

Hemp is one of the strongest natural fibres on earth, providing the durability of a synthetic fibre while still being fully biodegradable.

FuturFiber® hemp mats harness the strength and absorbency of hemp fibre creating a moist environment for plant growth, while providing unmatched weed suppression qualities.

- BioGro™ certified for organic input. Ensures it meets international standards
- Made from New Zealand hemp fibres blended with pure sheep's wool guaranteeing unmatched sustainability and quality
- Discourages weed growth and eliminates the need to apply harmful herbicides
- Superior water holding capabilities
- Very porous so will not impede air circulation or water and fertiliser penetration
- Mitigates soil temperature fluctuations for surface roots
- Designed to biodegrade over time
- Manufactured in New Zealand

Custom size rolls up to 6m wide can be requested as well as custom weights 300 - 1200gsm



Important: Before installing mulch matting or weed matting, thorough eradication of weeds from the area to be covered is strongly recommended. We advise spraying the site with an Organic Herbicide and allowing a few days before installing the matting.

| Code | Size | Pack Qty |
|-------|--------------------|----------|
| 23086 | 1m x 30m - 600gsm | 1 Roll |
| 23073 | 2m x 30m - 600gsm | 1 Roll |
| 23094 | 2m x 20m - 1000gsm | 1 Roll |



FuturFiber® Hemp Mulch Mats

600gsm

- Pre-punched holes for easy insertion of pins, pegs or bamboo stakes when used with plant guards



600gsm

| Code | Size | Pack Qty |
|-------|--------------------|----------|
| 23055 | 360mm ² | 1 Mat |
| 23058 | 450mm ² | 1 Mat |
| 23095 | 600mm ² | 1 Mat |

FuturFiber® Hemp Plant Guard Mats

750gsm

- 250mm² mats are designed for all other plant guards including TriGuards, SquareGuards and FiberGuards in all sizes
- Fixing pins not normally required



750gsm PlantGuard Mats

| Code | Size | Pack Qty |
|-------|--------------------|----------|
| 23059 | 250mm ² | 50 Mats |

FuturFiber® Hemp Pot Mats

600gsm

- Available in discs or squares
- Custom sizes available on request



| Code | Size | Pack Qty |
|-------|-------------------|----------|
| 23087 | 140mm Ø | 50 Mats |
| 23084 | 160mm Ø | 50 Mats |
| 23088 | 230mm Ø | 50 Mats |
| 23089 | 250mm Ø | 50 Mats |
| 23090 | 300mm Ø | 50 Mats |
| 23091 | 350mm Ø | 50 Mats |
| 23098 | 70mm ² | 100 Mats |
| 23099 | 80mm ² | 100 Mats |

Ecotex™ Mulch Mat

Weed Control Fabric 150gsm

- Chemical-free suppression of weeds
- Fully decomposes in 3+ years, leaving no residues
- Made from PLA with added hemp
- Robust fire resistant material designed to withstand tough conditions

| Code | Size | Pack Qty |
|-------|----------|----------|
| 23485 | 2m x 50m | 1 Roll |



FuturFiber® Dag Wool Matting Rolls

600gsm, 750gsm & 1000gsm

100% natural FuturFiber® Dag Matting Rolls are manufactured from BioGro Certified Dag wool and are recommended for small and large scale planting projects where soil conservation and weed suppression are required.

- Reduces planting stress by staying damp for hours, allowing effective penetration of water and fertiliser while maintaining air circulation
- Helps reduce evaporation and maintain warmer soil temperatures in colder conditions
- Feeds plants naturally, releasing nitrogen, sulphur, sodium, potassium, and magnesium into the soil over time
- Suppresses competing vegetation by blocking sunlight, eliminating the need for ongoing herbicide use
- Designed to last through the establishment phase and gradually biodegrade over time (may break down faster in wet conditions)
- Visually unobtrusive, blending naturally into the landscape and reducing visual pollution on revegetation projects
- Manufactured in New Zealand using natural dag wool
- Suitable for erosion control, weed suppression, sediment control, stream bank and river embankment stabilisation, landscaping, and use as a natural separation layer

*Use our biodegradable weed mat pins to secure your dag wool matting.
See page 42*



Important: Before installing mulch matting or weed matting, thorough eradication of weeds from the area to be covered is strongly recommended. We advise spraying the site with an Organic Herbicide and allowing a few days before installing the matting.

| Code | Size | Pack Qty |
|--------|--------------------|----------|
| 23O46 | 2m x 30m - 600gsm | 1 Roll |
| 23O22 | 2m x 30m - 750gsm | 1 Roll |
| 23O24D | 2m x 20m - 1000gsm | 1 Roll |



FuturFiber® Dag Wool Mulch Mats

600gsm

- Pre-punched holes for easy insertion of pins, pegs or bamboo stakes when used with plant guards



600gsm

| Code | Size | Pack Qty |
|--------|--------------------|----------|
| 23O47B | 360mm ² | 1 Mat |
| 23O41B | 450mm ² | 1 Mat |
| 23O35B | 600mm ² | 1 Mat |

FuturFiber® Dag Wool Plant Guard Mats

750gsm

- 200mm² mats are designed for CombiGuard and CombiShield
- 250mm² mats are designed for all other plant guards including TriGuards, SquareGuards and FiberGuards in all sizes
- Fixing pins not normally required



750gsm PlantGuard Mats

| Code | Size | Pack Qty |
|--------|--------------------|----------|
| 23O54B | 200mm ² | 50 Mats |
| 23O31B | 250mm ² | 50 Mats |

FuturFiber™ Dag Wool Pot Mats

600gsm

- Available in discs or squares
- Custom sizes available on request

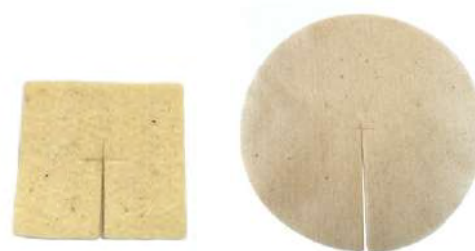
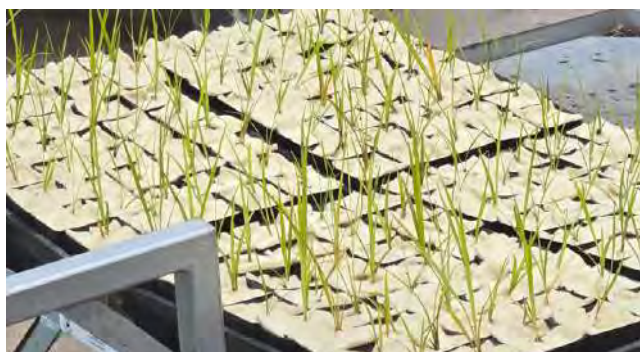

| Code | Size | Pack Qty |
|-------|-------------------|----------|
| 23O20 | 70mm ² | 100 Mats |
| 23O29 | 80mm ² | 100 Mats |
| 23O04 | 140mm Ø | 50 Mats |
| 23O05 | 160mm Ø | 50 Mats |
| 23O06 | 230mm Ø | 50 Mats |
| 23O14 | 250mm Ø | 50 Mats |
| 23O17 | 300mm Ø | 50 Mats |
| 23O19 | 350mm Ø | 50 Mats |

EcoWool™ Mulch Matting Rolls 600 & 1000gsm

- Manufactured in New Zealand from waste wool
- Recommended for small and large scale planting projects
- Discourages weed growth eliminating the ongoing need to apply herbicides
- Very porous so will not impede air circulation or water and fertiliser penetration
- Improves plant growth by trapping heat and moisture in the ground, increasing root development and extending the growing season
- Stabilises soil and reduces erosion on sloping sites
- Designed to biodegrade over 1-3 years dependent on gsm (may reduce in wet conditions).
- Releases valuable nutrients into the soil as it degrades (nitrogen, sulphur, sodium, potassium and magnesium)



Custom size rolls up to 6m wide can be requested as well as custom weights 300 - 1200gsm

Important: Before installing mulch matting or weed matting, thorough eradication of weeds from the area to be covered is strongly recommended. We advise spraying the site with an Organic Herbicide and allowing a few days before installing the matting.

| Code | Size | Pack Qty |
|-------|--------------------|----------|
| 3026H | 1m x 30m - 600gsm | 1 Roll |
| 23026 | 2m x 30m - 600gsm | 1 Roll |
| 23024 | 2m x 20m - 1000gsm | 1 Roll |

EcoWool™ Mulch Mats 600 & 1000gsm

- Pre-punched holes for easy insertion of pins, pegs or bamboo stakes when used with plant guards

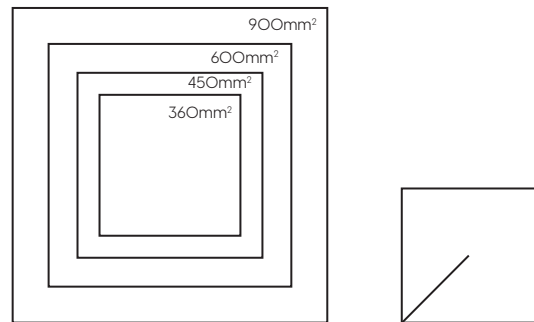

| Code | Size | Weight | Pack Qty |
|--------|--------|---------|----------|
| 23047L | 360mm² | 600gsm | 1 Mat |
| 23041L | 450mm² | 600gsm | 1 Mat |
| 23035L | 600mm² | 600gsm | 1 Mat |
| 23052L | 900mm² | 600gsm | 1 Mat |
| 23047E | 360mm² | 1000gsm | 1 Mat |
| 23041E | 450mm² | 1000gsm | 1 Mat |
| 23035E | 600mm² | 1000gsm | 1 Mat |

EcoWool Mulch Pot Mats

600gsm

- Available in discs or squares
- Custom sizes available on request



| Code | Size | Pack Qty |
|-------|-------------------|----------|
| 23015 | 70mm ² | 100 Mats |
| 23018 | 80mm ² | 100 Mats |
| 23007 | 140mm Ø | 50 Mats |
| 23009 | 160mm Ø | 50 Mats |
| 23003 | 230mm Ø | 50 Mats |
| 23008 | 250mm Ø | 50 Mats |
| 23010 | 300mm Ø | 50 Mats |
| 23011 | 350mm Ø | 50 Mats |

EcoWool™ and EcoCoir™ Plant Guard Mats

- 200mm² mats are designed for CombiGuard and CombiShield
- 250mm² mats are designed for all other plant guards including TriGuards, SquareGuards and FiberGuards in all sizes
- Fixing pins not normally required

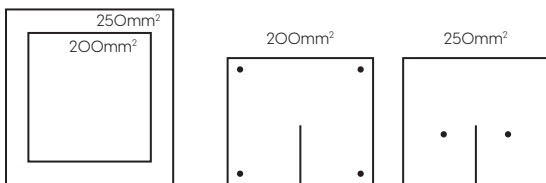

EcoWool™ Plant Guard Mats

| Code | Size | Pack Qty |
|--------|-----------------------------|----------|
| 23054H | 200mm ² (750gsm) | 50 Mats |
| 23031H | 250mm ² (750gsm) | 50 Mats |



EcoCoir™ Plant Guard Mats

| Code | Size | Pack Qty |
|-------|------------------------------|----------|
| 23766 | 200mm ² (1000gsm) | 1 Mat |
| 23758 | 250mm ² (1000gsm) | 1 Mat |

EcoJute Reinforced Mulch Matting Rolls

550 & 750gsm Grade

- Similar benefits to EcoWool™
- 100% natural product designed to biodegrade overtime
- Manufactured from a high density needle punched jute fibre
- Reinforced with a tough jute-twine grid for extra stability
- Stabilises soil and reduces erosion on sloping sites
- Provides weed suppression temporarily until plants establish
- A natural alternative to synthetic weed matting



For installation, allow
approx 80 pegs per roll.
See page 42

Important: Before installing mulch matting or weed matting, thorough eradication of weeds from the area to be covered is strongly recommended. We advise spraying the site with an Organic Herbicide and allowing a few days before installing the matting.

| Code | Size | Pack Qty |
|---------------|-------------------|----------|
| 23056 | 2m x 30m - 550gsm | 1 Roll |
| 23053 | 2m x 30m - 750gsm | 1 Roll |
| 23053D | 2m x 25m - 750gsm | 1 Roll |

EcoJute Pre-slit Reinforced Mulch Matting

550 & 750gsm Grade

- Pre-slit with 4 planting holes per square metre
- Eliminates the need for cutting on-site speeding up installation and reducing labour costs
- Ideal for weed suppression and erosion control during early plant establishment

| Code | Size | Pack Qty |
|----------------|-------------------|----------|
| 23056PS | 2m x 30m - 550gsm | 1 Roll |
| 23053PS | 2m x 30m - 750gsm | 1 Roll |



Synthetic Matting

Terrafelt™ Weed Matting

150gsm

- Very popular needle punched Polyester - felted finish for strength
- Three to four year UV rating
- Offers the advantage of lower cost matting with longer durability
- Hydrophilic - allows water to penetrate and soil to breathe

| Code | Size | Pack Qty |
|-------|-----------|----------|
| 23435 | 2m x 100m | 1 Roll |
| 23482 | 4m x 100m | 1 Roll |

Important: Before installing mulch matting or weed matting, thorough eradication of weeds from the area to be covered is strongly recommended. We advise spraying the site with an Organic Herbicide and allowing a few days before installing the matting.



Terrafelt™ Mulch Mats

150gsm

- Pre-punched holes for easy insertion of pins, pegs, or bamboo stakes

| Code | Size | Pack Qty |
|-------|--------------------|----------|
| 23032 | 360mm ² | 100 Mats |
| 23037 | 450mm ² | 100 Mats |



Polymat Plus™ Weed Matting

80gsm

- Economy grade weed matting
- Spun bonded UV-stable polypropylene
- Suppresses weeds and allows water penetration



| Code | Size | Pack Qty |
|-------|----------|----------|
| 23395 | 1m x 50m | 1 Roll |
| 23396 | 2m x 50m | 1 Roll |

Woven Heavy Duty Weed Matting

110gsm

- Superior protection for nursery floors
- Manufactured from woven UV stabilised polypropylene
- Nursery grade strength and resistance to tearing
- Requires securing with weedmat pins
- Good in situations where pedestrian access and foot traffic is likely



| Code | Size | Pack Qty |
|-------|---------------------------|----------|
| 23109 | 0.915m x 50m (with lines) | 1 Roll |
| 23119 | 1.83m x 50m (with lines) | 1 Roll |
| 23136 | 3.66m x 50m (with lines) | 1 Roll |

Weed Mat Fixings

BioPegs

100% Biodegradable

- 100% biodegradable natural product
- Anti-shatter technology
- Barbs create 45% more grip than 130mm metal staples
- Use with erosion control blankets, mulch mats and weed control blankets
- 150mm size for regular and loose or sandy soils

| Code | Size | Pack Qty |
|-------|---------|----------|
| 25871 | 150mm L | 200 Pegs |
| 25872 | 150mm L | 500 Pegs |

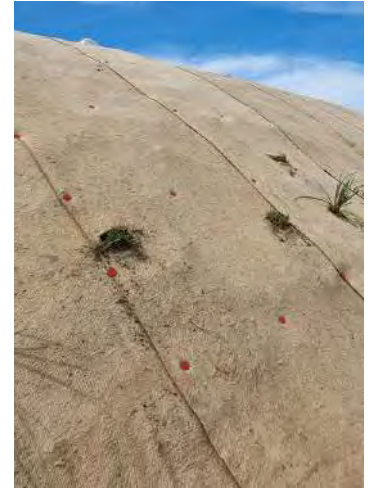

BioPins

100% Biodegradable

- 100% biodegradable natural product
- Used in situations where environmental considerations are a priority
- Fit well with heavier grade mattings eg. 750gsm
- Ideal for areas where pedestrian access may occur

| Code | Size | Pack Qty |
|-------|-----------------|----------|
| 25890 | 120mm L | 200 Pins |
| 25891 | 175mm L | 200 Pins |
| 25893 | 280mm Gripper L | 200 Pins |



Greenstake Pins

100% Biodegradable

- 100% biodegradable natural product
- Ideal for use with erosion control blankets and mulch mats
- 100mm size has 45% more grip than 130mm metal staples

| Code | Size | Pack Qty |
|--------|---------|----------|
| 25895H | 100mm L | 100 Pins |
| 25895 | 100mm L | 500 Pins |

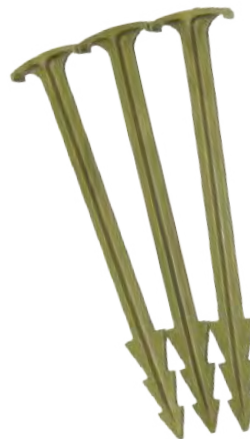

Natural Timber Weedmat Pegs

100% Biodegradable

- 100% biodegradable natural product
- The ideal pin to anchor root-balls to prevent pukeko pulling out plants
- Robust, durable product available in three convenient sizes to accommodate various soil types
- Effective performance for 12-36 months, depending on conditions
- Ideal for use alongside erosion control blankets, mulch mats, and weed control blankets



Note: These are not ideal for rocky terrain. The mat is secured by the top nodule that grips the mat. Avoid hammering them all the way down to prevent the nodule from piercing through the mat. For added grip, angle the pegs while banging them in

| Code | Size | Ctn Qty |
|-------|---------|----------|
| 25700 | 150mm L | 500 Pegs |
| 25701 | 180mm L | 500 Pegs |
| 25703 | 240mm L | 500 Pegs |
| 25704 | 280mm L | 500 Pegs |

M100 Staple Gun and Staples

Fast Installation

- Increase productivity and reduce labour costs for stapling down erosion control blankets, geotextiles, sod and landscape fabrics
- Made from laser-cut, precision steel parts
- An experienced operator can fix over 3,000 staples per hour
- Holds 100 staples (150mm long)
- Height: 970mm, depth 390mm, handle width: 340mm
- Spare parts available
- 3 year manufacturer's warranty
- M100 staples are 2.5mm gauge taped into cassettes of 50 for easy handling
- M100 staples are high tensile 1700 MPa steel

| Code | Size | Pack Qty |
|-------|------------------|--------------|
| 25881 | M100 Staple Gun | 1 Staple Gun |
| 25897 | 32mm W x 150mm L | 1000 Staples |



Up to 7 times faster than pinning by hand.

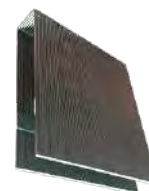

TerraGear™ Rubber Mallet

- 16oz/490g size
- 285mm length
- Minimal bounce back and vibration
- Excellent weight for quick insertion of pins/pegs

| Code | Description | Pack Qty |
|-------|---------------|----------|
| 26029 | Rubber Mallet | 1 Mallet |



Ground Staples

- For securing weed matting and erosion control blanket
- Fabricated from galvanised wire
- Available in 130mm, 150mm and 230mm lengths
- 230mm length is designed for soft soil situations

| Code | Size | Pack Qty |
|-------|---------|-------------|
| 25045 | 130mm L | 200 Staples |
| 25046 | 230mm L | 200 Staples |





Erosion Control

- 46 Erosion Blankets and Mesh
- 48 Erosion Control Logs

Erosion Blankets and Mesh

EcoCoir Blanket

300gsm & 450gsm Reinforced Grade

- EcoCoir is used extensively on steep slopes where erosion from wind and rainfall is likely
- Made from sustainable natural coconut fibres with jute or cotton reinforcing
- Facilitates plant growth by providing insulation to spreading root systems
- Biodegradable
- Protects exposed soil from wind and water
- Retains moisture
- Available in 300gsm and 450gsm grades
- Supplied in 50 m rolls with a 2.4 m width for quick and efficient installation



| Code | Size | Pack Qty |
|-------|---------------------|----------|
| 23751 | 2.4m x 50m - 300gsm | 1 Roll |
| 23752 | 2.4m x 50m - 450gsm | 1 Roll |



EcoCoir Erosion Control Mesh

400 & 900gsm

- Eco-friendly coconut fibre erosion mesh
- Durable, natural anti-erosion blanket
- Ideal for windy, high-rainfall areas
- Commonly used on steep slopes before hydroseeding
- Protects seeds and mulch during germination
- Reinforces soil while vegetation establishes
- Open weave (no weed suppression)
- Available in 400gsm (general use) and 900gsm (steep/high runoff areas)

Applications

- Slope protection (exposed faces)
- Channels and swale drains
- Erosion protection (wind, shoreline, stream bank and runoff erosion)
- Steep batters



| Code | Size | Pack Qty |
|-------|-------------------|----------|
| 23760 | 2m x 25m - 400gsm | 1 Roll |
| 23761 | 2m x 25m - 900gsm | 1 Roll |

EcoWool Erosion Control Blanket

45Ogsm

- 45Ogsm biodegradable erosion control blanket
- Manufactured in New Zealand from 100% local wool fibre
- Densely needle punched to provide superior erosion control
- Suitable for slopes, swales, landscaping, and revegetation applications
- Protects soil and seed until adequate plant establishment is achieved
- Permeable with excellent moisture retention to support vegetation in drier climates reducing planting stress
- Protects exposed soils from wind and rain, reducing sediment runoff
- Allows effective penetration of water and fertiliser and circulation of air
- Reduces evaporation by absorbing moisture and releasing heat
- Helps maintain soil temperature in cold conditions and protects against frost
- Naturally feeds plants by releasing nitrogen, sulphur, sodium, potassium, and magnesium into the soil over time
- Gradually biodegrades over a short-term period after installation while maintaining erosion control



| Code | Size | Pack Qty |
|-------|---------------------|----------|
| 23756 | 2.4m x 50m - 45Ogsm | 1 Roll |

Hessian Grass-Strike Mesh

Natural Grass Establishment

- Natural hessian 14 oz grade mesh used to establish grass and turf
- Seed is spread on the soil surface, then hessian cloth is laid on top
- Provides protection from environmental elements while allowing light and moisture to reach the seed for germination
- Helps prevent soil erosion and bird damage for more successful turf establishment
- Breaks down naturally into the soil overtime

| Code | Size | Pack Qty |
|-------|-------------|----------|
| 23730 | 1.83m x 50m | 1 Roll |



Erosion Control Logs

EcoCoir Logs

- EcoCoir logs are a totally biodegradable solution for controlling erosion on hills, banks, stream boundaries, shorelines etc.
- Easy to install, provides immediate erosion control and creates the perfect microclimate for the establishment of new plantings
- Biodegrades in 3-5 years giving ample time for plantings to take over



| Code | Size | Pack Qty |
|--------------|------------------------|----------|
| 23753 | EcoCoir Log 200mm x 3m | 1 Log |
| 23767 | EcoCoir Log 300mm x 3m | 1 Log |

EcoWool Logs

- High-performance, locally sourced alternative to conventional coir logs
- New Zealand-made biodegradable solution for erosion control
- Suitable for hills, banks, stream boundaries, shorelines, slopes, and drainage channels
- Made from 100 percent recycled wool fibre
- Act as a natural barrier that slows water runoff and traps sediment
- Helps prevent soil loss and manage sediment in areas prone to water scour
- Lightweight and flexible for easy handling
- Simply secured in place using timber stakes
- Ideal for steep terrain and difficult-to-access sites
- Naturally biodegrade over time, contributing to improved soil health
- Support environmentally responsible land management practices



| Code | Size | Pack Qty |
|--------------|------------------------|----------|
| 23748 | EcoWool Log 200mm x 3m | 1 Log |
| 23749 | EcoWool Log 300mm x 3m | 1 Log |



Plant Establishment

| | |
|----|---------------------------------|
| 50 | Browsing Repellent and Sprayers |
| 51 | Fertiliser |
| 52 | Planting and Growing |
| 54 | Water Saving |

Browsing Repellent and Sprayers

Plantskydd® Animal Repellent

Plantskydd® is a 100% natural spray-on repellent effective against most herbivorous pests such as rabbits, possums, hares and deer.

Developed in Sweden in the 1990's, Plantskydd is now used successfully throughout Europe, North America and New Zealand to protect young plantings from animal browse.

- Plantskydd comes as a water-soluble powder and is applied via a pressure sprayer to young plants
- Popular with foresters, commercial planters, nurseries, and home gardeners across New Zealand
- The smell is not offensive to applicators
- Provides proven protection for up to 6 months on dormant plants and 3–4 months during the active growing season
- Lasts up to twice as long as other repellents, reducing application frequency and overall cost
- Offers all-season protection for annuals, shrubs, perennials, fruit trees, conifers, deciduous trees, and native plants
- Does not wash off - this product is rainfast within 24 hours and does not require reapplication after rain

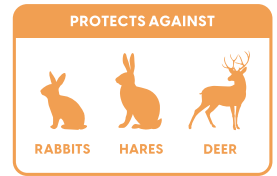

Use with our 10L or 16L sprayers.

| Code | Description | Pack Qty |
|-------|-------------|----------|
| 22034 | 10kg Pack | 1 Pack |
| 22033 | 1kg Pack | 1 Pack |
| 22035 | 200g Pack | 1 Pack |
| 22037 | 25kg Box | 1 Pack |

10L Sprayer

- 10L backpack sprayer with a diaphragm pump
- Manually adjustable pressure regulator
- Durable 50cm lance
- Practical robust trigger handle
- Foldaway pump handle
- The UV-resistant plastic container is ergonomically designed for maximum wearer comfort



| Code | Description | Pack Qty |
|-------|-------------------------|-----------|
| 26112 | 10L Sprayer (Solo 473D) | 1 Sprayer |

TerraGear™ 16L Knapsack Sprayer

- Top-quality, Kiwi-designed 16-litre knapsack sprayer
- Features waterproof shoulder pads to prevent chemical absorption and body contamination
- Suitable for both left and right-handed users
- Equipped with a metal wand for durable and reliable spraying



| Code | Description | Pack Qty |
|-------|---------------------------------|-----------|
| 26069 | TerraGear™ 16L Knapsack Sprayer | 1 Sprayer |

Fertiliser

Terrapro Fertiliser Tablets

Nutrient rich slow release fertiliser for newly planted seedlings

- Nutrient-rich, slow-release fertiliser tablets with Nitrogen, Phosphorus, Potassium, Magnesium, and trace elements
- Ideal for New Zealand soils
- NPK ratio: 20-4-4
- Slowly release nutrients over 2-3 years
- For new plantings place tabs in the hole prior to bedding the plant
- For existing plants create a spade cut near the root system and place tabs in the cut
- Suitable for orchards, forestry, vineyards, nurseries, and other plantings
- Available in 1 kg packs, 10 kg, and 20 kg cartons



*Small plants - 1-2 tabs per plant
Larger plants - 3-5 tabs per plant*

| Code | Description | Pack Qty |
|-------|-------------|----------|
| 24O37 | 1kg Bag | 1 Bag |
| 24O40 | 10kg Box | 1 Box |
| 24O42 | 20kg Box | 1 Box |

Polygon (Smart) Fertiliser

Formulated for turf, landscape and nursery applications

- Temperature-driven nutrient release
- Minimal surge growth and low burn potential
- Low potential for nutrient leaching, run-off or volatilisation
- Dust-free handling and long shelf life
- NPK values see below



| Code | Description | Longevity | Pack Qty |
|-------|--------------------|------------|---------------|
| 24O35 | Polygon 16-6-12+TE | 5-6 mths | 1 x 25kg sack |
| 24O34 | Polygon 16-6-11+TE | 8-9 mths | 1 x 25kg sack |
| 24O33 | Polygon 15-6-12+TE | 12-14 mths | 1 x 25kg sack |
| 24O32 | Polygon 15-6-11+TE | 18-20 mths | 1 x 25kg sack |

Planting and Growing

Terrablock Root Barrier

Heavy Duty

- Heavy duty recycled HDPE
- Flexible yet extremely durable
- Resistant to UV, chemicals and fungus
- Prevents the migration and spreading of plant roots that can cause costly damage to pavements, roads, building foundations and buried installations
- Root barrier can save property owners hundreds of thousands of dollars annually in expensive repair bills from intrusive roots



| Code | Description | Pack Qty |
|-------|-------------|----------|
| 23221 | 0.5m x 50m | 1 Roll |
| 23220 | 0.6m x 50m | 1 Roll |
| 23212 | 1.0m x 50m | 1 Roll |
| 23215 | 1.5m x 50m | 1 Roll |

FuturaFiber® Hemp Wonton Planting Bags

Hemp Wonton Planting Bags are specially designed to establish native plants in areas where there is little or no planting media. They are made from dag wool fibres or a blend of NZ grown hemp and dag wool fibres. Wonton planting bags are 100% biodegradable.

- Ideal for plants prone to transplant shock, allowing planting without root disturbance
- Creates an insulated environment that supports healthy establishment and growth in poor or inadequate ground conditions
- Provides nutrients as the bag naturally breaks down
- Bags are filled with soil prior to planting and secured with attached natural hessian twine to prevent soil loss during inundation
- Suitable for use in braided rivers, riparian planting, stormwater outfalls, swale drains, and high-velocity waterways
- Made in New Zealand by Advance Landscape Systems using blended FuturaFiber® hemp and dag wool
- Designed to fit 1L–1.5L plants (enquire for custom size planting bags)
- 100% natural and biodegradable



| Code | Description | Pack Qty |
|-------|-------------------------------|----------|
| 23126 | Hemp Wonton Planting Bags | 1 Bag |
| 23125 | Dag Wool Wonton Planting Bags | 1 Bag |

Planter Bags

- Good quality heavy micron planter bags
- Manufactured from UV-stabilised polyethylene to protect from degradation



| Code | Description | Pack Qty |
|-------|---------------------------------------|----------|
| 25972 | PB3/4 Bags (0.67L) 80mu 64 x 150mm | 100 Bags |
| 25973 | PB1 1/2 Bags (0.90L) 80mu 90 x 150mm | 100 Bags |
| 25974 | PB2 Bags (1.2L) 80mu 90 x 200mm | 100 Bags |
| 25975 | PB3 Bags (1.7L) 80mu 100 x 200mm | 100 Bags |
| 25976 | PB5 Bags (2.8L) 80mu 120 x 230mm | 100 Bags |
| 25977 | PB6 1/2 Bags (3.6L) 100mu 130 x 280mm | 100 Bags |
| 25978 | PB10 Bags (5.6L) 80mu 120 x 460mm | 100 Bags |
| 25970 | PB8 Bags (4.5L) 125mu 140 x 280mm | 100 Bags |
| 25971 | PB12 Bags (6.75L) 125mu 160 x 320mm | 100 Bags |
| 25979 | PB18 Bags (10L) 125mu 180 x 360mm | 100 Bags |
| 25981 | PB28 Bags (12L) 125mu 200 x 420mm | 100 Bags |
| 25982 | PB40 Bags (18L) 125mu 230 x 460mm | 100 Bags |
| 25983 | PB60 Bags (36L) 150mu 260 x 500mm | 50 Bags |

Grow-Your-Own Microgreen Kit

- Suitable for commercial growers
- Grow-Your-Own Microgreen Kit includes everything needed to get started – just add seeds and water
- Microgreens are nutrient-dense, rich in vitamins, minerals, and antioxidants, and support gut health
- Easy to grow at home using minimal space
- Grown on a natural fibre hemp mat instead of soil for a clean, fresh growing process

Kit includes:

- 2 x Microgreen trays (25x51cm)
- 1 x Microgreen mesh tray (for bottom watering)
- 1 x Humidity dome
- 1 x Glass spray bottle
- 5 x Pack of hemp grow mats
- 3 x Pack of assorted seeds
- Step-by-step Microgreen Growing Guide



| Code | Description | Pack Qty |
|-------|------------------------------|----------|
| 23070 | Grow-Your-Own Microgreen Kit | 1 Kit |

Microgreen Hemp Grow Mats

- Fits 25 x 51 cm Grow-Your-Own Microgreen Kit trays
- 100% natural, biodegradable, and compostable, made from hemp fibres with cellulose binding
- Highly absorbent, holding up to 1050% of its weight in water to support seed growth

| Code | Description | Pack Qty |
|--------|-------------|----------|
| 23043A | 25cm x 51cm | 10 Mats |
| 23043P | 25cm x 51cm | 140 Mats |



Water Saving

TreeSip Watering Bags

75 Litre

- Simple, efficient, and cost-effective watering solution for young trees during establishment
- Easy to install and fill in minutes; can be moved between trees or joined for larger trunks
- Dual drip holes release water slowly over several hours for deep soil saturation
- Provides efficient watering during dry or drought conditions
- Ideal for sandy soils where other watering methods may be less effective
- Minimises evaporation and run-off
- No digging, staking, or tools required
- Durable and flexible, designed for harsh New Zealand conditions with a 5-year UV rating
- One bag suits trees up to 8 cm in diameter (with clear lower branches to 630 mm)
- Two bags can be joined for trees up to 20 cm in diameter (maximum of two bags)

| Code | Description | Pack Qty |
|-------|----------------------------|----------|
| 25987 | TreeSip Watering Bag - 75L | 1 Bag |



Usage & Handling:

- Use clean water only to prevent drip holes from blocking
- Fill one-third first and lift slightly to seat the base correctly before fully filling
- Do not unzip, move, or transport when full
- Do not suspend or hang by the handles
- Avoid sharp objects and keep away from small children

TreeSip Watering Ring

75 Litre

- Low-profile watering ring designed for efficient irrigation of trees and shrubs up to 15cm in diameter
- 5–8 hour drip system delivers deep, consistent watering for healthy growth
- Encourages strong root development with recommended 3–4 day intervals between waterings.
- Quick and easy to set up
- Welded tag with staking hole allows secure anchoring in windy conditions
- Built tough for New Zealand conditions with a 5-year UV rating
- Width 950mm, Height 100mm



| Code | Description | Pack Qty |
|-------|-----------------------------|----------|
| 25988 | TreeSip Watering Ring - 75L | 1 Ring |

Stockosorb™

Granular water retention crystals

Stockosorb stores hundreds of times its weight in water. On demand, as soil conditions turn dry, nutrient-rich water is released to the plant root zone where it is most needed.

Stockosorb helps create constant moisture conditions in the root zone of the plant. It provides a moisture buffer against insufficient rainfall and watering, heat and drought, resulting in stronger and healthier plant growth.

- The same product as crystal rain
- Improves water and nutrient storage capacity in the soil
- Improves the survival rate of plants
- Promotes uniform plant growth and greater root growth
- Compatible with all types of soils and growing media
- Horticultural applications such as revegetation, landscape planting, vegetable gardens or even turf applications
- Non-toxic and environmentally safe



| Code | Description | Pack Qty |
|-------|-------------------------|----------|
| 53055 | 1kg Box | 1 Bag |
| 53056 | 10kg Box | 1 Box |
| 53049 | 20kg Box | 1 Box |
| 53057 | Water Crystal Dispenser | 1 Unit |

Sustainability

To be sustainable is to make responsible use of natural resources to ensure the long-term health of the ecological systems in which we are enmeshed. Sustainability is the beacon of our progress. Everything we do at Advance Landscape Systems is based on sustainability, environmental friendliness, and consciousness.

We are devoted to partnering with community organisations to promote ecological results and conservation. We also assist corporations and land developers in adopting innovative processes that allow them to achieve their sustainability goals in the short and long run. As the custodians of green investments, we always prioritise sustainability.



Recyclable Scheme Products

Advance Landscape Systems is the first firm in the landscaping industry to offer to collect and recycle plastic from its customers. We offer a wide selection of biodegradable and sustainable plant guards, but many people prefer plastic guards since they are so versatile and affordable.

As a firm that strives to provide environmentally friendly solutions to its clientele, we stay true to our commitment to sustainability while offering a wide selection of items to meet the needs of all of our customers with our recyclable scheme products.

When biodegradable products are not an option, we offer our clients the service of returning plastic products to us instead of discarding them. We compile these products and send them to our partner, Future Post, where they will undergo Future Post's recycling process and be transformed into fence posts.





Ground Reinforcement

- 58 Porous Pavers
- 59 Reinforcement Grid and Mesh

Porous Pavers

TerraPave

100% Recycled Content Porous Pavers

- Stabilise ground in erosion-prone areas
- Reduce stormwater runoff and improve natural drainage
- Suitable for parking areas and low-traffic surfaces
- High load capacity of 160–200 T/m²
- Manufactured from 100% recycled plastic
- Non-toxic and chemically inert
- Durable, permeable, and aesthetically pleasing
- Panel size: 500 × 500 × 40 mm

Applications

- Car parks and driveways
- Aircraft taxiways and helipads
- Wheelchair access routes
- Pedestrian walkways
- Golf buggy paths
- Equestrian arenas
- Livestock standing areas
- Track stabilisation

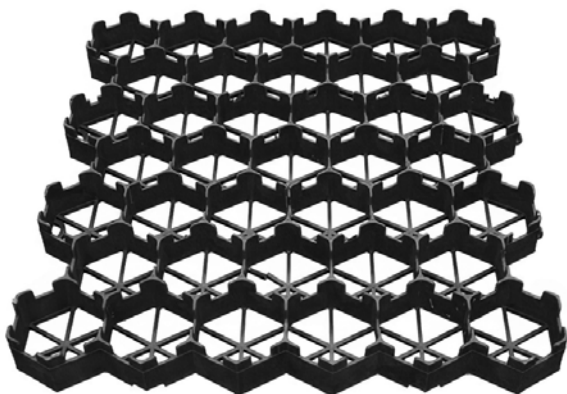

| Code | Description | Area/m ² | Pack Qty |
|-------|---------------|---------------------|----------|
| 23878 | Porous Pavers | 4pcs/m ² | 4 Pavers |

GrassInforce™

Grass Reinforcement Mesh

- Heavy-duty polyethylene mesh for reinforcing grassed surfaces
- Protects against rutting and vehicle wheel damage while allowing grass to grow through
- Simple installation with butted edges secured using fixing pins
- Suitable for permanent or temporary grass reinforcement
- High load performance of up to 8 tonnes per axle
- Fast, cost-effective installation compared to plastic paving grids
- Minimal ground preparation required; excavation often not necessary
- Improved traction and grip compared to straight-orientated protection meshes
- Available in 11 mm standard and 14 mm heavy-duty thicknesses

Applications

- Grass overspill car parks and domestic driveways
- Front lawns and grass verge parking
- Boat and caravan parking areas
- Golf course buggy paths and maintenance vehicle routes
- Emergency vehicle access routes
- Caravan parks and agricultural event areas



| Code | Description | Pack Qty |
|-------|-------------|----------|
| 23901 | 2m x 20m | 1 Roll |
| 23903 | 2m x 10m | 1 Roll |
| 23902 | 2m x 5m | 1 Roll |

GrassInforce™ Ground Staples

- Steel ground staples designed to secure GrassInforce™ Ground Reinforcement Mesh
- Manufactured from durable steel for reliable ground fixing
- Staple dimensions: 170 x 70 mm, 6 mm diameter
- Outer mesh edges fixed at 300–350 mm centers
- Central fixing points installed at 500–750 mm centers



| Code | Description | Pack Qty |
|-------|-------------------------------|------------|
| 23907 | Ground Staples HD 6mm x 170mm | 50 Staples |

ACEGrid

Soil Reinforcement Grid

- High-performance woven geogrid for short and long-term soil reinforcement
- Engineered with strength in both longitudinal and transverse directions
- Imparts significant tensile strength to reinforced soils
- Suitable for use with naturally occurring soil types
- Compatible with the Flex MSE Vegetated Wall System (page 64)
- High tensile strength with low creep characteristics
- High fibre interlock strength
- Excellent soil interaction and pull-out resistance
- Suitable for long-term reinforcement applications (100+ years)
- Chemically inert and resistant to degradation
- UV resistant for prolonged sunlight exposure



| Code | Description | Pack Qty |
|--------|---------------------|----------|
| 26079 | 4m x 50m | 1 Grid |
| 26079C | 4m per lineal metre | 1 Grid |

ACEGrid is ideal for use with
Flex MSE®
See page 62



Flex MSE[®] Vegetated Wall System



Before Construction



During Planting



Established



Flex MSE® Vegetated Wall System

EPD Certified

Flex MSE® is a patented engineered solution for vegetated retaining walls and erosion control. Flex MSE bags and interlocking plates are used to build naturally resilient geomodular structures. A unique soft building material which exhibits hard material qualities, Flex MSE adapts to events that would ruin lesser systems, and only gets stronger and greener as time goes on. Flex MSE is a patented system which leverages Mechanically Stabilized Earth (MSE) principles along with geotextile technology to create strong and easy to install geomodular block structures.

Advantages

- Easy to install and maintain
- Uses 97% less greenhouse gas than concrete
- Great for installation in areas with difficult access
- Able to withstand almost unlimited differential settlement
- Certified Environmental Product Declaration (EPD)

| Code | Description | Pack Qty |
|--------|-----------------------------------|----------|
| 26086 | Flex MSE® Bag & Plate | 1 Unit |
| 26086F | Flex MSE® Bag & Plate (Prefilled) | 1 Unit |



Flex MSE® components:

- 1 x Flex MSE Bag
- 1 x Flex MSE Plate

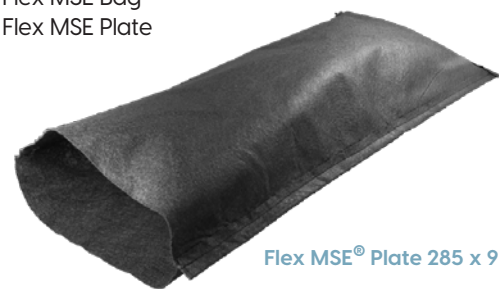

Flex MSE® Plate 285 x 99mm



Flex MSE® Bag 890 x 380mm



Flex MSE® Bag (Prefilled)
700-750mm x 300mm

Building with Flex MSE®

Flex MSE is one of the easiest systems on the market to install, vegetate and maintain.



Flex MSE bags are:

- ✓ Filled with sand and organics
- ✓ An ideal 'planter block' for many types of vegetation
- ✓ Water and root permeable
- ✓ Flexible enough to create almost any contour or angle

Flex MSE plates are:

- ✓ Designed to bridge the gap between bags to create an interlocking mechanical connection
- ✓ Engineered with friction strips for greater bag to bag mechanical connection and Geogrid hooks to connect to soil reinforcement



1 Flex MSE® cuts installation times
 Flex MSE® walls install in 2/3 to 1/2 of the time of conventional walls.

2 Longevity
 Flex MSE®'s 120 year design life with 75 year system warranty means lifetime costs can be 1/4 of conventional systems.

3 Flex MSE® is often more cost effective than other systems
 Savings in machine, labour, material and transportation costs make Flex MSE® an obvious choice for helping generate project cost savings.

4 Flex MSE® walls are easy to construct
 DIY'ers to professional contractors can install Flex MSE® using our simple installation methods.

5 Flex MSE® is designed to be planted or hydroseeded
 A Flex MSE® wall, once vegetated, blends into the natural landscape for an aesthetically pleasing result.

6 Flex MSE® is ideal for a wide variety of applications
 Flex MSE® works seamlessly with utilities and landforms and integrates perfectly with other building materials and systems.

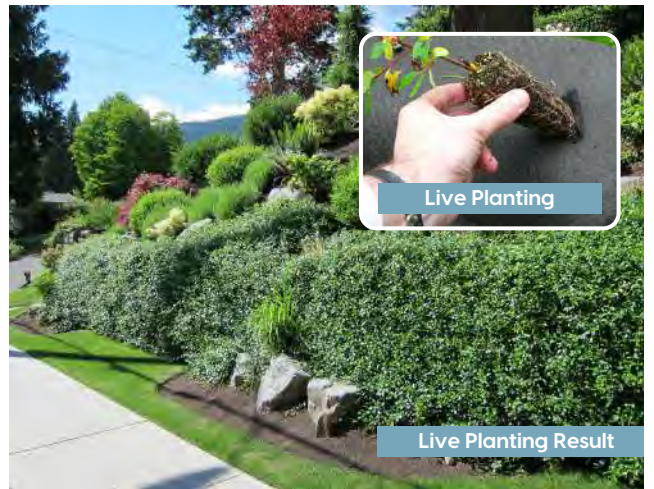

The Flex MSE® Vegetated Wall system provides the strength of interlocking components without the need for concrete, rebar, wire mesh or other formwork.

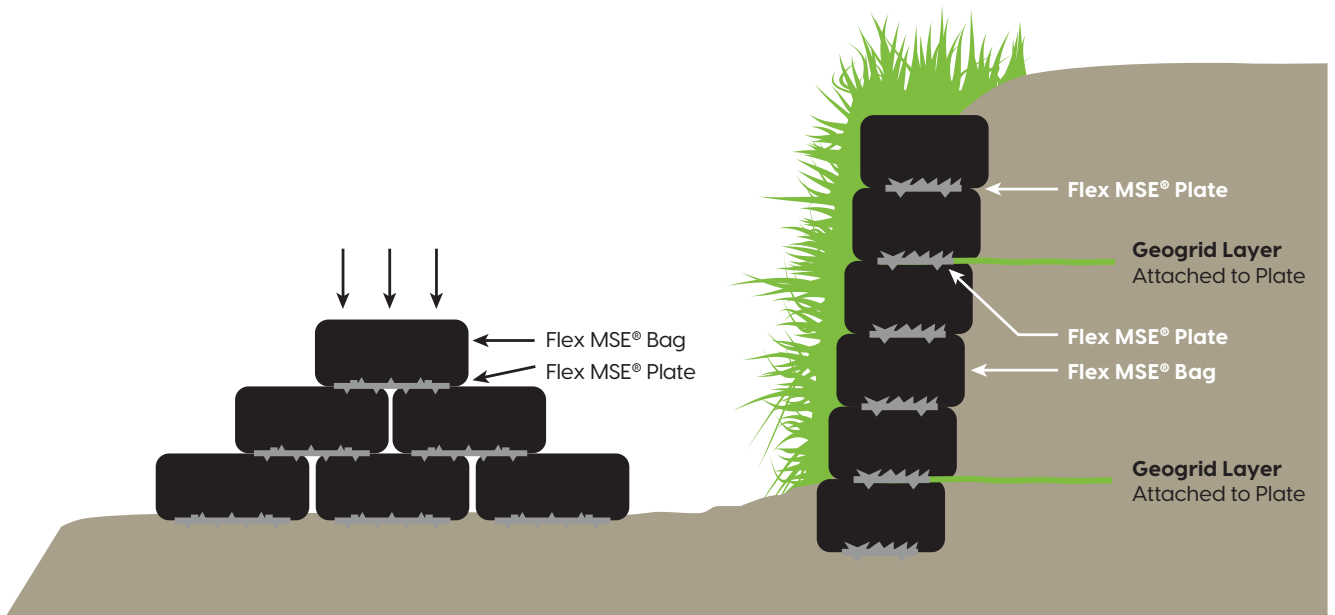



Fabrics and Accessories

- 66 Windbreak Cloth and Accessories
- 68 Shade Cloth and Privacy Mesh
- 69 Horticultural Fabrics

Windbreak Cloth and Accessories

Windbreak Cloth

Standard/Medium

- Protects new plantings from damage by desiccating winds
- UV stabilised for longevity
- Gram weight of approx 110gsm for Standard
- Gram weight of approx 120gsm for Medium
- Requires staking or wire support



STANDARD Windbreak Cloth 110gsm (Wind Porosity Approx. 60-65%)

| Code | Size | Colour | Pack Qty |
|-------|-------------|--------|----------|
| 4013 | 0.91m x 50m | Green | 1 Roll |
| 4013B | 0.91m x 50m | Black | 1 Roll |
| 4012 | 1.83m x 50m | Green | 1 Roll |
| 4019 | 3.66m x 50m | Green | 1 Roll |

MEDIUM Windbreak Cloth 120gsm (Wind Porosity Approx. 55-60%)

| Code | Size | Colour | Pack Qty |
|-------|-------------|--------|----------|
| 4032 | 1m x 50m | Green | 1 Roll |
| 4032B | 1m x 50m | Black | 1 Roll |
| 4033 | 1.83m x 50m | Green | 1 Roll |
| 4033B | 1.83m x 50m | Black | 1 Roll |

Windbreak Cloth

Heavy Duty

- The heavyweight of all windbreaks with a wind porosity of around 45-55%
- Gram weight of approx 140+gsm
- Used in more demanding applications including boundary fencing, internal and external fencing and site fencing
- Life span of 10 years plus



HEAVY Windbreak Cloth 140gsm (Wind Porosity Approx. 45-50%)

| Code | Size | Colour | Pack Qty |
|-------|--------------|--------|----------|
| 4037 | 1m x 50m | Green | 1 Roll |
| 4037B | 1m x 50m | Black | 1 Roll |
| 4043 | 1.83m x 50m | Green | 1 Roll |
| 4043B | 1.83m x 50m | Black | 1 Roll |
| 4044 | 2.74m x 100m | Green | 1 Roll |
| 4044B | 2.74m x 100m | Black | 1 Roll |
| 4048 | 3.66m x 100m | Green | 1 Roll |
| 4048B | 3.66m x 100m | Black | 1 Roll |



Natural Hessian Dune Fencing

Biodegradable windbreak and sand trapping system

- Biodegradable hessian, environmentally suitable for coastal and dune restoration projects
- Heavy-duty sewn hems on top and bottom for improved strength and durability in exposed coastal conditions
- Sisal drawstring in the top hem allows fencing to be tensioned for optimal performance
- Sewn eyelets at 1500 mm centres for secure and easy fixing to posts or stakes
- Reduces wind speed to protect young plants from exposure
- Encourages sand trapping to promote dune building on the leeward side
- Compatible with untreated stakes, meeting DOC and environmental requirements



| Code | Description | Pack Qty |
|-------|--|----------|
| 23732 | Natural Hessian Dune Fencing 925mm x 25m 450gsm | 1 Fence |

Windbreak Nail Plates

- Great way to secure Windbreak and Shade Cloth fabric to timber posts or framing
- Simply tighten fabric to required tension then press nail plate through fabric and hammer firmly into timber
- Provides a tidy finish to patio or deck areas



| Code | Description | Pack Qty |
|------|-------------|-----------------|
| 4026 | Nail Plates | 50 Nail Plates |
| 4027 | Nail Plates | 500 Nail Plates |

Advance Butterfly Clips

- Multi-purpose simple to snap on clips
- Used to attach silt fencing, windbreak or shade cloth to a holding wire



| Code | Description | Pack Qty |
|------|-----------------|-----------|
| 4021 | Butterfly Clips | 100 Clips |

Shade Cloth and Privacy Mesh

Shade Cloth

- Shade Cloth has many different uses including protecting plants, nursery stock, people and farm livestock from the effects of sunlight, heat, wind and ultra violet rays
- The shade factor will depend on the density of the fabric
- Available in 30, 50, 70 and 90% shade



| Code | Size | Colour | Pack Qty |
|---------------------|-------------|--------|----------|
| 25-30% Shade | | | |
| 4064 | 1.83m x 50m | Green | 1 Roll |
| 4065 | 2m x 50m | Green | 1 Roll |
| 4065W | 2m x 50m | White | 1 Roll |
| 4066 | 3.66m x 50m | Green | 1 Roll |
| 4067 | 4m x 50m | Green | 1 Roll |
| 4067W | 4m x 50m | White | 1 Roll |
| 50-60% Shade | | | |
| 4056 | 1.83m x 50m | Green | 1 Roll |
| 4056B | 1.83m x 50m | Black | 1 Roll |
| 4057 | 2m x 50m | Green | 1 Roll |
| 4057B | 2m x 50m | Black | 1 Roll |
| 4057W | 2m x 50m | White | 1 Roll |
| 4058 | 3.66m x 50m | Green | 1 Roll |
| 4058B | 3.66m x 50m | Black | 1 Roll |
| 4059 | 4m x 50m | Green | 1 Roll |
| 4059B | 4m x 50m | Black | 1 Roll |
| 4059W | 4m x 50m | White | 1 Roll |
| 70-80% Shade | | | |
| 4052 | 1.83m x 50m | Green | 1 Roll |
| 4052B | 1.83m x 50m | Black | 1 Roll |
| 4051 | 2m x 50m | Green | 1 Roll |
| 4051B | 2m x 50m | Black | 1 Roll |
| 4051W | 2m x 50m | White | 1 Roll |
| 4053 | 3.66m x 50m | Green | 1 Roll |
| 4053B | 3.66m x 50m | Black | 1 Roll |
| 4054 | 4m x 50m | Green | 1 Roll |
| 4054B | 4m x 50m | Black | 1 Roll |
| 4054W | 4m x 50m | White | 1 Roll |
| 90% Shade | | | |
| 4055 | 1.83m x 50m | Green | 1 Roll |
| 4055B | 1.83m x 50m | Beige | 1 Roll |

Privacy Mesh

- High-density fabric reduces visibility
- Includes eyelets for easy installation
- Can be attached with cable ties, wire ties, or Advance Butterfly Clips
- Requires strong fence frames to handle heavy wind loading
- Versatile as visual block, windbreak, or dust screen for construction or commercial sites
- Durable, lasting up to five years outdoors
- Allows approximately 15% wind porosity



| Code | Description | Pack Qty |
|------|-----------------------------|----------|
| 4070 | 1.83m x 50m Black 85% Shade | 1 Roll |

Horticultural Fabrics

Frost Cloth

Frost Cloth (Light) – 20–35gsm

- Very lightweight spun-bonded fabric
- Supplied in bulk rolls
- Provides limited protection against frost
- White in colour
- Allows light and UV penetration to support plant photosynthesis



Frost Cloth – Micronet (Heavy) – 80gsm

- Premium 80gsm knitted frost control fabric
- Creates a protective microclimate to promote plant growth
- Helps protect plants from frost, rain, hail, and bird damage
- Partially translucent (not completely white when laid out)

| Code | Description | Pack Qty |
|------|-------------------------|----------|
| 4103 | 2m x 5m 20gsm (Light) | 1 Roll |
| 4104 | 2m x 10m 30gsm (Light) | 1 Roll |
| 4100 | 2m x 100m 30gsm (Light) | 1 Roll |
| 4086 | 2m x 10m 80gsm (Heavy) | 1 Roll |
| 4087 | 2m x 50m 80gsm (Heavy) | 1 Roll |
| 4088 | 4m x 50m 80gsm (Heavy) | 1 Roll |

Bird Netting

- Long-life, knitted netting with up to 10-year lifespan
- Designed to protect crops, vines, and plants from pests such as birds and opossums
- Constructed with 16mm diamond-shaped mesh
- Made from UV-stabilised HDPE for strong resistance to sunlight
- Lightweight throw-over bird netting (30gsm)
- Suitable for greenhouse vents
- Ideal for general crop and plant protection
- Commonly used as vine netting



| Code | Description | Pack Qty |
|-------|----------------|----------|
| 4080 | 4m x 2m Black | 1 Net |
| 4081 | 4m x 4m Black | 1 Net |
| 4082 | 10m x 4m Black | 1 Net |
| 4083 | 4m x 25m Black | 1 Net |
| 4084 | 4m x 50m Black | 1 Net |
| 4084G | 4m x 50m Green | 1 Net |
| 4084W | 4m x 50m White | 1 Net |

Bug Netting

- Lightweight fabric designed to protect crops and plants from insect damage
- Minimal shade factor to support healthy plant growth
- Allows water and air to permeate through the fabric
- Fabric weight: 45gsm
- Made from HDPE
- Approximate mesh size: 2mm x 1mm
- Green in colour
- Ideal for domestic garden use
- Suitable for use over cloche frames



| Code | Description | Pack Qty |
|------|-------------|----------|
| 4031 | 4m x 30m | 1 Net |

Integrity

Integrity and honesty are fundamental to everything we do. We are an honest, hardworking team resolving problems for other honest, hardworking groups. So, we support our clients and partners with not only innovative solutions but also the best advice.

In addition to providing eco-friendly landscape products to landscape workers and land developers, we also work as your trusted consultants. We value you and your trust in our initiatives more than anything. So, you can rest assured we will never suggest a product unless we are 100% sure that it will help you achieve your planting and sustainability goals.



Innovation

Today's inventive world supports innovation, creativity, and out-of-the-box thinking when it comes to problem-solving. Innovation is essential in every field as it allows for the free exploration of ideas.

We are proactive in our efforts to resolve issues that big land developers face in terms of product effectiveness and sustainability. This demands cutting-edge innovative solutions to overcome the environmental problems caused by the planting and agricultural industry.

Therefore, at Advance Landscape Systems, we design innovative and user-friendly products and solutions that address genuine environmental problems.

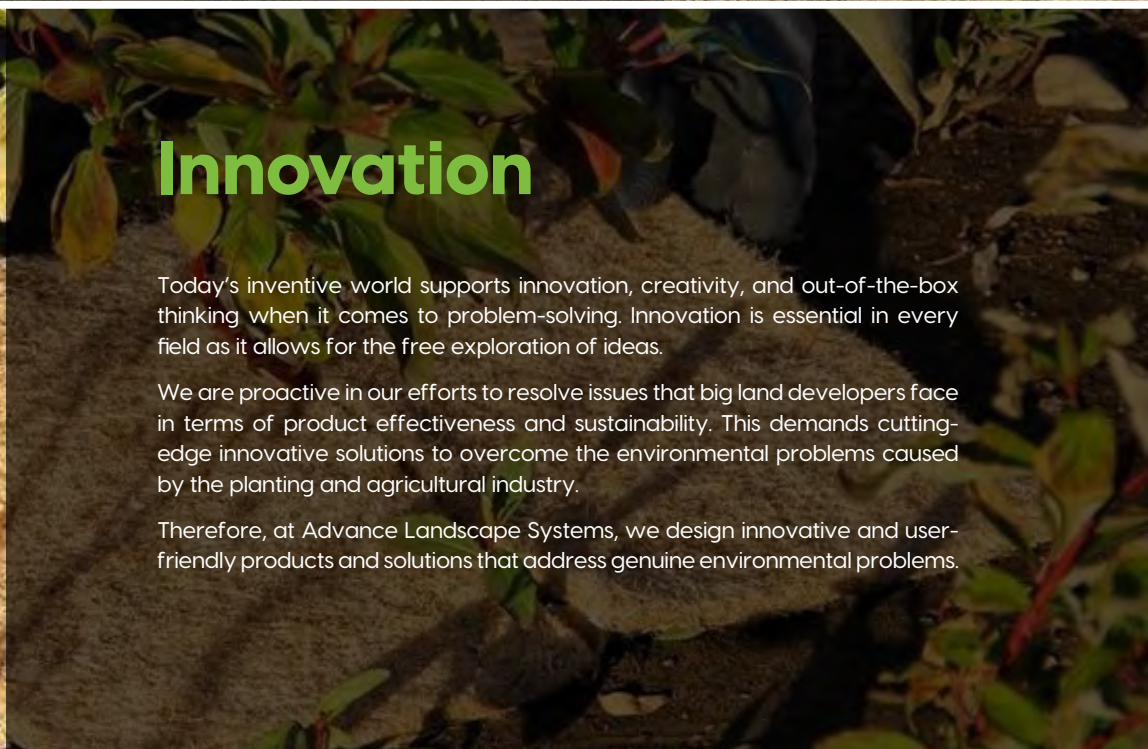

Support

Whether you are a small business or a large landscaping corporation, Advance Landscape Systems can provide the support you need to take your landscaping and re-vegetation endeavors to the next level.

Since there is a wide range of climate and topography in NZ, we tailor our recommendations to each client's specific needs and, if relevant, their available resources. Most of our shipments are sent to rural areas and major landscape projects encompassing thousands of square meters, and we strive to make the process as simple as possible.

Furthermore, we work with licensed engineers and architects to offer you comprehensive support throughout the design process when you purchase a Flex MSE wall. Our team is always available and happy to help our clients find the information and products they need. Reach out to us today!





Water Management

- 72 Filter Fabrics
- 73 Culvert Flume
- 74 Pond Liner

Filter Fabrics

Filter Fabric

60gsm

- Non-woven anti-silting fabric for improved drainage management
- Helps prevent tree roots from penetrating and forming root balls in drainage systems
- Fine pores discourage root and grass growth
- Ideal for embankments, ditches, weed control, and as an anti-slumping membrane
- Suitable for wrapped French drains to prevent silt and fines from clogging the system
- Can be wrapped around perforated plastic pipes to reduce silt blockage



| Code | Size | Pack Qty |
|-------|----------|----------|
| 26000 | 1m x 10m | 1 Roll |
| 26001 | 1m x 20m | 1 Roll |
| 26003 | 1m x 50m | 1 Roll |
| 26005 | 2m x 10m | 1 Roll |
| 26006 | 2m x 20m | 1 Roll |
| 26008 | 2m x 50m | 1 Roll |

Filter Fabric Premium

100gsm

- Heavier-grade non-woven, needle-punched geotextile
- Porous yet dimensionally stable
- Thermally treated for increased strength
- Ideal for drainage, filtration, and protection



| Code | Size | Pack Qty |
|--------|------------|----------|
| 260091 | 0.6m x 50m | 1 Roll |
| 260092 | 1m x 50m | 1 Roll |
| 260093 | 1.9m x 50m | 1 Roll |

Filter Sock

- Durable solution for stormwater protection, perimeter control, and drainage filtration
- Made from tough knitted polyester
- Filters fine particles to prevent clogging and extend drainage system life
- Available preloaded for quick installation
- Delivers consistent performance
- Meets RTA 3553 standards
- Available in various sizes to suit site requirements



Preloaded Filter Sock

| Code | Size | Pack Qty |
|-------|-----------------------|----------|
| 26012 | 65mm x 15m Preloaded | 1 Sock |
| 26013 | 65mm x 30m | 1 Sock |
| 26014 | 65mm x 30m Preloaded | 1 Sock |
| 26015 | 110mm x 15m | 1 Sock |
| 26016 | 110mm x 15m Preloaded | 1 Sock |
| 26017 | 110mm x 30m | 1 Sock |
| 26018 | 110mm x 30m Preloaded | 1 Sock |
| 26019 | 110mm x 50m Preloaded | 1 Sock |
| 26020 | 110mm x 100m | 1 Sock |
| 26022 | 160mm x 45m | 1 Sock |

Culvert Flume

Culvert Flume

Heavy-duty premium grade flume

- Heavy-duty, premium-grade flume made from flexible HydraFlex polyethylene fabric
- Designed to safely direct water from culvert outlets
- Ideal for road, farm, and infrastructure drainage applications
- Heavyweight material with specialised weave for improved puncture, tear strength, and flatness
- Coated for enhanced toughness and abrasion resistance
- Intended for exposed applications up to 10-years
- Helps prevent soil erosion on roadside embankments
- Features 1 or 2 cleats with twin eyelets spaced approx. 1.5m apart for flume pegs
- 10-year UV degradation guarantee (pro rata)

Our culvert flumes are manufactured to order. Please allow 2-3 days plus delivery time.



| Code | Size | Pack Qty |
|---|---------|---------------|
| Culvert Flume Single Cleat (One side of Flume) | | |
| 44299 | 250mm Ø | 1 lined metre |
| 44301 | 300mm Ø | 1 lined metre |
| 44304 | 450mm Ø | 1 lined metre |
| Culvert Flume Double Cleat (Both sides of Flume) | | |
| 44311 | 300mm Ø | 1 lined metre |
| 44312 | 375mm Ø | 1 lined metre |
| 44314 | 450mm Ø | 1 lined metre |
| 44315 | 525mm Ø | 1 lined metre |
| 44316 | 600mm Ø | 1 lined metre |
| 44317 | 675mm Ø | 1 lined metre |
| 44318 | 750mm Ø | 1 lined metre |
| 44319 | 825mm Ø | 1 lined metre |
| 44320 | 900mm Ø | 1 lined metre |

Culvert Flume Clips and Pegs

- Clips are designed to fit over large diameter pipes to secure flume to pipe end
- Pegs are made of 1cm steel rod bent into a U-shape at one end to peg flume down through eyelets



Culvert Flume Pegs

| Code | Size | Pack Qty |
|-------|---------------------|----------|
| 44336 | Flume Peg 350-400mm | 1 Peg |



Culvert Flume Clips

| Code | Size | Pack Qty |
|-------|---------|----------|
| 44324 | 225mm Ø | 1 Clip |
| 44325 | 300mm Ø | 1 Clip |
| 44326 | 375mm Ø | 1 Clip |
| 44328 | 450mm Ø | 1 Clip |
| 44329 | 525mm Ø | 1 Clip |
| 44330 | 600mm Ø | 1 Clip |
| 44331 | 675mm Ø | 1 Clip |
| 44332 | 750mm Ø | 1 Clip |
| 44333 | 825mm Ø | 1 Clip |
| 44334 | 900mm Ø | 1 Clip |

Pond Liner

HydraFlex Pro Pond Liner

Premium Grade Polyethylene Liner 414gsm

- Flexible, reinforced polyethylene (RPE) liner for high-performance pond and containment use
- 414gsm with 0.750mm nominal thickness; reinforced with woven HDPE scrim and dual-side coatings
- Engineered for strength, puncture resistance, and UV stability
- 20-year UV warranty for long-term outdoor exposure
- Lightweight and flexible for easy handling and installation
- Prefabricated and welded in-house to exact dimensions; ready for immediate use without specialised equipment



| Code | Description | Colour |
|-------|--|--------|
| 44212 | HydraFlex Pro Pond Liner (any m ² size) | Black |

HydraFlex Pond Liner

Premium Grade Polyethylene Liner 309gsm

- Flexible, reinforced polyethylene (RPE) liner for ponds and containment applications
- 309gsm with 0.60mm nominal thickness; reinforced with woven HDPE scrim and dual-side coatings
- Engineered for strength, puncture resistance, and UV stability
- 10-year UV warranty for long-term outdoor use
- Lightweight and flexible for easy handling and installation
- Prefabricated and welded in-house to exact dimensions; ready to install without specialised equipment



| Code | Description | Colour |
|-------|--|--------|
| 44211 | HydraFlex Pond Liner (any m ² size) | Black |

Polypropylene Pond Liner

Aquamark® Polypropylene Pond Liner

- Durable, lightweight, and flexible polypropylene liner for ponds, dams, tanks
- UV-stabilised coating with 20-year UV warranty
- Certified potable water safe (AS/NZS 4020) non-leaching
- 400gsm, 0.50mm nominal thickness; 100% recyclable
- Double heat-welded joints for watertight performance
- High-strength layered construction with woven base for stability and durability
- Ready-to-install prefabricated sizes, no specialised equipment required

Our custom size pond liners are manufactured to order. Please allow 2-3 days plus delivery time.



| Code | Description | Colour |
|-------|--|--------|
| 44210 | Polypropylene Pond Liner (any m ² size) | Black |



Field, Track and Site

- 76 Site Marking and End Caps
- 77 Track Marking and Pest Tracking
- 78 Anti-Slip Mesh

Site Marking and End Caps

Spot Marking Spray

- SiteX Spot Marking Spray Paint available in six bright colours, including three fluorescents
- Ideal for use on soil, bitumen, concrete, timber and steel
- High-quality choice for contractors, landscapers, and drainage professionals
- Can be used inverted for easy ground marking
- Superior paint formulation with quick-drying time, proven across Australasia
- Trigger-style cap compatible with most spray wands for faster application and reduced fatigue



| Code | Description | Pack Qty |
|--------|--------------------------|----------|
| 261O3O | Fluoro Orange 400g/500ml | 1 Can |
| 261O3B | Fluoro Blue 400g/500ml | 1 Can |
| 261O3G | Fluoro Green 400g/500ml | 1 Can |
| 261O3P | Fluoro Pink 400g/500ml | 1 Can |
| 261O3R | Fluoro Red 400g/500ml | 1 Can |
| 261O3W | Fluoro White 400g/500ml | 1 Can |
| 261O3Y | Fluoro Yellow 400g/500ml | 1 Can |

Spray Marker Wand

- Designed for use with SiteX Spot Marking Spray
- Helps reduce back strain for contractors
- Insert the can into the wand and slide to the trigger point to start marking
- Fits most marker cans except those with side-pressure nozzles

| Code | Description | Pack Qty |
|--------|-------------|----------|
| 26133S | 600mm | 1 Wand |
| 26133 | 700mm | 1 Wand |



Y-Post End Caps

- Designed to fit firmly on to steel Y-Posts
- High-visibility end caps used as a safety precaution

| Code | Description | Pack Qty |
|-------|-----------------------|-------------|
| 26O65 | Y Post End Cap Yellow | 20 End Caps |

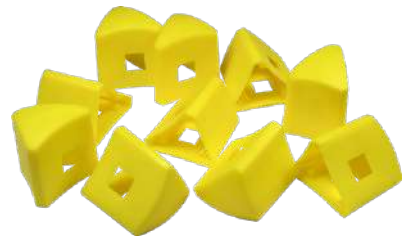

Track Marking and Pest Tracking

Track Marker Triangles

DOC Approved

- Made from UV stabilised plastic to withstand our harsh NZ conditions
- Small size dimensions 120mm x 120mm x 90mm
- Large size dimensions 310mm x 310mm x 285mm
- Used by Department of Conservation to mark out track directions in the great New Zealand outdoors
- Available in a range of colours
- Can also be made to required specifications
- Fibreglass rods can be used to mount track markers

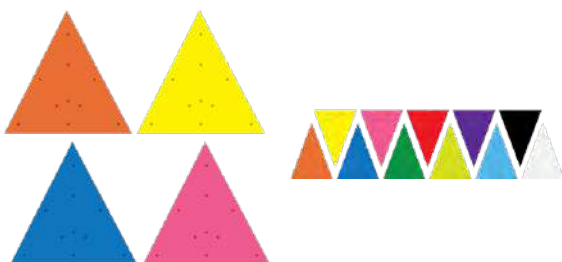

| Code | Description | Pack Qty |
|---------|--------------------|------------|
| 2616O | Small Orange | 20 Markers |
| 2616OB | Small Blue | 20 Markers |
| 2616OBK | Small Black | 20 Markers |
| 2616OFG | Small Fluoro Green | 20 Markers |
| 2616OG | Small Green | 20 Markers |
| 2616OLB | Small Lite Blue | 20 Markers |
| 2616OP | Small Purple | 20 Markers |
| 2616OPK | Small Pink | 20 Markers |
| 2616OR | Small Red | 20 Markers |
| 2616OW | Small White | 20 Markers |
| 2616OY | Small Yellow | 20 Markers |
| 2616I | Large Orange | 10 Markers |
| 2616IB | Large Blue | 10 Markers |
| 2616ILB | Large Lite Blue | 10 Markers |
| 2616IP | Large Purple | 10 Markers |
| 2616IPK | Large Pink | 10 Markers |
| 2616IR | Large Red | 10 Markers |
| 2616IW | Large White | 10 Markers |
| 2616IY | Large Yellow | 10 Markers |

Track Marker Stakes

Track Marker Y-Posts and Fibreglass Rods

- Robust recycled plastic orange y-posts for great visibility in green landscapes
- Solid lightweight fibreglass rods are non-conductive and non-corrosive
- Rods are flexible and can be used in many applications
- Easy to install
- Can be used with track marker triangles (see above)



| Code | Description | Pack Qty |
|--------|------------------------------------|------------|
| 260630 | Orange Plastic Y-Posts 1.5m x 40mm | 10 Y-Posts |
| 260640 | Orange Plastic Y-Posts 1.8m x 40mm | 10 Y-Posts |
| 26162 | Orange Fibreglass Rod 1.5m x 9.5mm | 10 Rods |

Tracking Tunnel and Ink

For Pest Animal Monitoring

- Monitors stoats, rats, mice, hedgehogs, and other pests
- Durable, UV-stabilised, flat-pack tunnel; reusable and recyclable
- Dimensions: 592 x 556 mm; includes pegs, staples, and tracking card
- Card and pegs lock into tunnel; meets National Protocol specifications
- Animal-safe ink captures clear footprints and resists drying
- 100 ml Tracking Ink bottle with sponge applicator covers approximately 100 cards



| Code | Description | Pack Qty |
|------|---------------------------------|----------|
| 1021 | Black Tracking Tunnel 592x556mm | 1 Kit |
| 1022 | Tracking Ink 100ml | 1 Bottle |

Anti-Slip Mesh

DekGrip™

Anti-Slip Mesh

- Anti-slip mesh overlay for wooden walkways, decks, bridges, viewing platforms, and marine access ways
- Provides safe grip in wet conditions and is ideal for public areas
- 10-year UV guarantee; made from UV-stabilised polypropylene
- Durable, mould and fungi resistant; withstands harsh New Zealand conditions
- Lightweight, easy to handle and install; can be trimmed to size with scissors, snips, or secateurs
- Internal square openings approx. 34mm; economical plastic construction avoids rust and sharp edges
- Available in three standard sizes; custom widths available on indent
- Rolls under 3.95m may require edge trimming before installation

Specifications

| | |
|-----------|--|
| Material | Polypropylene Biaxial Geogrid (TGSG30-30) |
| Color | Black |
| Treatment | UV Resistant - 2% UV inhibitor (HTUV100-Germany) |



MEETS SLIP RESISTANCE CLASSIFICATION AS 4586-2013



| Code | Description | Pack Qty |
|-------|-------------|----------|
| 26253 | 0.90m x 10m | 1 Roll |
| 26251 | 1.90m x 50m | 1 Roll |
| 26252 | 3.90m x 50m | 1 Roll |

DekGrip™ Stapler and Staples

- Heavy-duty stapler for securing DekGrip anti-slip mesh to wooden walkways, decks, bridges, and viewing platforms
- Features simple squeeze action, comfortable bi-material handle, and easy bottom loading for efficient installation
- Uses 14mm (9/16") staples, sold separately
- Recommended usage: 26 staples per square metre



| Code | Description | Pack Qty |
|-------|---------------------------------|--------------|
| 25965 | DekGrip AT-962 Cable Stapler | 1 Stapler |
| 25966 | DekGrip Galv Cable Staples 14mm | 1000 Staples |

Delfast Gas Stapler and Staples

- Delfast Gas 3.15 Stapler for quick installation of DekGrip™ on wooden surfaces
- Lightweight, portable, and powerful; no compressor required
- 3-4 times faster than hand stapling
- Adjustable depth and custom nose for accurate staple placement
- Comes with plastic carry case, two batteries, charger, and cigarette lighter adapter



| Code | Description | Pack Qty |
|-------|---------------------------------------|--------------|
| 25911 | Delfast Gas Stapler | 1 Stapler |
| 25912 | Delfast 33x3.15mm Staples & Fuel Cell | 2000 Staples |
| 25914 | Delfast 33x3.15mm Staples | 2700 Staples |

Index

Terms and Conditions can be viewed online www.advancelandscape.co.nz

| | | | |
|---|----|---|--------|
| A | | | |
| ACEGrid..... | 60 | Greenstake Pins..... | 42 |
| Animal Repellent (Plantskydd®)..... | 50 | Ground Staples..... | 44 |
| Antislip Mesh (DekGrip)..... | 78 | H | |
| B | | Hardwood Stakes 22mm..... | 11 |
| Bamboo Stakes..... | 14 | Hardwood Stakes 40mm..... | 11 |
| BioPegs..... | 42 | Hardwood Stakes 50mm..... | 10 |
| BioPins and Gripper..... | 42 | Hardwood Stakes 50mm Painted Black..... | 10 |
| Birdnet..... | 69 | Hardwood Tree Stakes 75mm..... | 10 |
| Blanket Roll, Erosion (EcoCoir)..... | 46 | Hemp Mulch Mat 60Ogsm (FuturFiber®)..... | 35 |
| Bug Netting..... | 69 | Hemp Mulch Matting (FuturFiber®)..... | 34 |
| Butterfly Clips (Advance)..... | 67 | Hemp Plant Guard Mats 75Ogsm (FuturFiber®)..... | 35 |
| C | | | 35 |
| Cable Stapler and Staples (DekGrip)..... | 78 | Hemp Pot Mats 60Ogsm (FuturFiber®)..... | 35 |
| Clips and Pegs, Culvert Flume..... | 73 | Hessian Grass-Strike Mesh..... | 47 |
| Cloth Garden Ties..... | 18 | Hexagonal Wire Netting..... | 28 |
| CombiGuard (KBC)..... | 25 | K | |
| CombiShield 300mm (KBC)..... | 24 | Knapsack Sprayer 16L (TerraGear™)..... | 50 |
| Culvert Flume..... | 73 | L | |
| D | | Logs, Erosion (EcoCoir)..... | 48 |
| Dag Wool Mulch Mat 60Ogsm (FuturFiber®)..... | 37 | Logs, Erosion (EcoWool)..... | 48 |
| | 37 | M | |
| Dag Wool Mulch Matting (FuturFiber®)..... | 36 | Macrocarpa Tree Stakes..... | 11 |
| Dag Wool Plant Guard Mats 75Ogsm (FuturFiber®)..... | 37 | Manuka Tree Stakes..... | 12 |
| Dag Wool Pot Mats 60Ogsm (FuturFiber®)..... | 37 | Marker Stakes, Track..... | 77 |
| Dune Fencing, Natural Hessian..... | 67 | Marker Triangles, Tracker..... | 77 |
| E | | Marker Wand, Spray..... | 76 |
| Erosion Control Blanket (EcoWool)..... | 47 | Mesh, Handy (KBC)..... | 28 |
| Erosion Mesh (EcoCoir)..... | 46 | Mesh, Privacy..... | 68 |
| Elastic Tree Tie Webbing..... | 15 | Mesh, Trunk Guard..... | 29 |
| End Cap, Y Post (Yellow)..... | 76 | Microgreen Hemp Grow Mats..... | 53 |
| Eslon Stakes..... | 13 | Microgreen Kit..... | 53 |
| F | | Mulch Mat (EcoWool Square)..... | 38 |
| Fencing Ring Plier and D Rings (G22)..... | 27 | Mulch Matting (EcoWool)..... | 38 |
| Fertiliser (Polyon)..... | 51 | Mulch Matting (Ecotex™)..... | 35 |
| Fertiliser Tablets (Terrapro)..... | 51 | Mulch Matting, Reinforced (EcoJute)..... | 40 |
| Filter Fabric 6Ogsm..... | 72 | Mulch Matting, Pre-slit (EcoJute)..... | 40 |
| Filter Fabric Premium..... | 72 | N | |
| Filter Sock..... | 72 | NetSleeve Roll (KBC)..... | 28 |
| Fiberglass Rod (White)..... | 13 | P | |
| FiberGuard (300mm, 450mm)..... | 21 | Pond Liner (HydraFlex)..... | 74 |
| FiberGuard 2.0 (300mm, 450mm)..... | 20 | Pond Liner Pro (HydraFlex)..... | 74 |
| Flower Sticks..... | 14 | Pond Liner, Polypropylene..... | 74 |
| Foam Wire Plant and Tree Tie..... | 18 | Porous Pavers (TerraPave)..... | 58 |
| Frost Cloth..... | 69 | Pot Mats (EcoWool)..... | 39 |
| G | | Plant Guard Hardwood Stakes..... | 11 |
| Gas Stapler and Staples (Delfast)..... | 78 | Plant Guard Mat (EcoCoir)..... | 39 |
| Grass Reinforcement Mesh (GrassInforce™)..... | 59 | Planter Bags..... | 53 |
| | 59 | Planting Bags, Wonton (FuturFiber®)..... | 52 |
| Grass Reinforcement Staples (GrassInforce™)..... | 59 | R | |
| | 59 | Recycled Plant and Tree Stakes..... | 12 |
| | | Reinforcing Rods, Steel..... | 12 |
| | | Root Barrier (Terrablock)..... | 52 |
| | | Rubber Mallet (TerraGear™)..... | 18, 44 |
| | | S | |
| | | Shadecloth..... | 68 |
| | | Site Marking Spray Paint (SiteX)..... | 76 |
| | | Sleeve, Spray (KBC)..... | 27 |
| | | Sleeve, Willow + Poplar (KBC)..... | 26 |
| | | Speedi Ties..... | 16 |
| | | Sprayer 10L (Solo 473D)..... | 50 |
| | | SquareGuard (KBC)..... | 23 |
| | | Staple Gun and Staples (J23/10)..... | 16 |
| | | Staple Gun and Staples (MIOO)..... | 43 |
| | | Stapler and Staples, Heavy Duty (VX550)..... | 16 |
| | | Super Soft Tree Ties..... | 16 |
| | | T | |
| | | Tapener Tool and Accessories..... | 17 |
| | | Tie Webbing, Jute..... | 15 |
| | | Tie Webbing, Poly..... | 15 |
| | | Tracking Tunnel / Tracking Ink..... | 77 |
| | | Tree Stake Rammer (TerraGear™)..... | 12 |
| | | Tree Stakes, Bamboo..... | 14 |
| | | Tree Stakes, Treated Pine..... | 8 |
| | | Tree Stakes, Treated Pine Painted Black..... | 9 |
| | | Tree Stakes, Treated Pine Rounded..... | 8 |
| | | Tree Stakes, Treated Pine Rounded Painted Black..... | 9 |
| | | Tree Stakes, Untreated Pine..... | 8 |
| | | Tree Stakes, Untreated Pine Painted Black..... | 9 |
| | | Tree Ties, Cable (TerraTie)..... | 17 |
| | | TreeTube Maxi (KBC)..... | 29 |
| | | TreeTube Rolls and Cut Lengths (KBC)..... | 29 |
| | | TriGuard (KBC)..... | 22 |
| | | V | |
| | | Vegetated Wall System (Flex MSE®)..... | 62 |
| | | W | |
| | | Water Retention Crystals and Dispenser (Stockosorb™)..... | 55 |
| | | Watering Bag (TreeSip)..... | 54 |
| | | Watering Ring (TreeSip)..... | 54 |
| | | Weed Mat Pegs, Natural Timber..... | 43 |
| | | Weed Matting, Heavy Duty Woven..... | 41 |
| | | Weed Matting (Polymat™ Plus)..... | 41 |
| | | Weed Matting (Terrafelt™)..... | 41 |
| | | Weed Mulch Mats (Terrafelt™)..... | 41 |
| | | Windbreak Cloth (Standard, Medium, Heavy Duty)..... | 66 |
| | | Windbreak Nail Plates..... | 67 |
| | | Wire Netting, Hexagonal..... | 28 |

Order Online
advancelandscape.co.nz

0800 600 789
sales@advancelandscape.co.nz

Auckland Warehouse: 13 Matukutūruru Road, Wiri, Auckland 2104

Christchurch Warehouse: 491 Waterloo Road, Christchurch 8042

Northland Branch: 6 Springs Flat Road, Kamo, Whangarei 0112